

SONY[®]

4-287-973-11(2)

Multi Channel AV Receiver

Operating Instructions

<http://www.sony.net/>

©2011 Sony Corporation Printed in Malaysia



* 4 2 8 7 9 7 3 1 1 * (2)

STR-DA5700ES

WARNING

To reduce the risk of fire or electric shock, do not expose this apparatus to rain or moisture.

To reduce the risk of fire, do not cover the ventilation opening of the apparatus with newspapers, tablecloths, curtains, etc. Do not place the naked flame sources such as lighted candles on the apparatus.

Do not install the appliance in a confined space, such as a bookcase or built-in cabinet.

To reduce the risk of fire or electric shock, do not expose this apparatus to dripping or splashing, and do not place objects filled with liquids, such as vases, on the apparatus.

As the main plug is used to disconnect the unit from the mains, connect the unit to an easily accessible AC outlet. Should you notice an abnormality in the unit, disconnect the main plug from the AC outlet immediately.

Do not expose batteries or apparatus with battery-installed to excessive heat such as sunshine, fire or the like.

The unit is not disconnected from the mains as long as it is connected to the AC outlet, even if the unit itself has been turned off.



This symbol is intended to alert the user to the presence of the Hot Surface that may be hot if it is touched during the normal operation.



This symbol is intended to alert the user to the presence of uninsulated “dangerous voltage” within the product’s enclosure that may be of sufficient magnitude to constitute a risk of electric shock to persons.



This symbol is intended to alert the user to the presence of important operating and maintenance (servicing) instructions in the literature accompanying the appliance.

For customers in the United States

Owner’s Record

The model and serial numbers are located on the rear of the unit. Record these numbers in the space provided below. Refer to them whenever you call upon your Sony dealer regarding this product.

Model No. _____ Serial No. _____

Important Safety Instructions

- 1) Read these instructions.
 - 2) Keep these instructions.
 - 3) Heed all warnings.
 - 4) Follow all instructions.
 - 5) Do not use this apparatus near water.
 - 6) Clean only with dry cloth.
 - 7) Do not block any ventilation openings. Install in accordance with the manufacturer’s instructions.
 - 8) Do not install near any heat sources such as radiators, heat registers, stoves, or other apparatus (including amplifiers) that produce heat.
 - 9) Do not defeat the safety purpose of the polarized or grounding-type plug. A polarized plug has two blades with one wider than the other. A grounding type plug has two blades and a third grounding prong. The wide blade or the third prong are provided for your safety. If the provided plug does not fit into your outlet, consult an electrician for replacement of the obsolete outlet.
 - 10) Protect the power cord from being walked on or pinched particularly at plugs, convenience receptacles, and the point where they exit from the apparatus.
 - 11) Only use attachments/accessories specified by the manufacturer.
 - 12) Use only with the cart, stand, tripod, bracket, or table specified by the manufacturer, or sold with the apparatus. When a cart is used, use caution when moving the cart/apparatus combination to avoid injury from tip-over.
- 
- 13) Unplug this apparatus during lightning storms or when unused for long periods of time.

14) Refer all servicing to qualified service personnel. Servicing is required when the apparatus has been damaged in any way, such as power-supply cord or plug is damaged, liquid has been spilled or objects have fallen into the apparatus, the apparatus has been exposed to rain or moisture, does not operate normally, or has been dropped.

– Consult the dealer or an experienced radio/TV technician for help.

CAUTION

You are cautioned that any changes or modifications not expressly approved in this manual could void your authority to operate this equipment.

To reduce the risk of electric shock, the speaker cord should be connected to the apparatus and the speakers in accordance with the following instructions.

- 1) Disconnect the AC power cord from the MAINS.
- 2) Strip 10 to 15 mm of the wire insulation of the speaker cord.
- 3) Connect the speaker cord to the apparatus and the speakers carefully so as not to touch the core of speaker cord by hand. Also disconnect the AC power cord from the MAINS before disconnecting the speaker cord from the apparatus and the speakers.

The following FCC statement applies only to the version of this model manufactured for sale in the U.S.A. Other versions may not comply with FCC technical regulations.

NOTE:

This equipment has been tested and found to comply with the limits for a Class B digital device, pursuant to Part 15 of the FCC Rules. These limits are designed to provide reasonable protection against harmful interference in a residential installation.

This equipment generates, uses and can radiate radio frequency energy and, if not installed and used in accordance with the instructions, may cause harmful interference to radio communications. However, there is no guarantee that interference will not occur in a particular installation. If this equipment does cause harmful interference to radio or television reception, which can be determined by turning the equipment off and on, the user is encouraged to try to correct the interference by one or more of the following measures:

- Reorient or relocate the receiving antenna.
- Increase the separation between the equipment and receiver.
- Connect the equipment into an outlet on a circuit different from that to which the receiver is connected.

About This Manual

- The instructions in this manual are for model STR-DA5700ES (the receiver). Check your model number by looking at the lower right corner of the front panel.
- The instructions in this manual describe mostly the operation of the receiver with the supplied remote control. You can also use the buttons or knobs on the receiver if they have the same or similar names as those on the remote control.

On Copyrights

This receiver incorporates Dolby* Digital and Pro Logic Surround and the DTS** Digital Surround System.

- * Manufactured under license from Dolby Laboratories.
Dolby, Pro Logic, Surround EX, and the double-D symbol are trademarks of Dolby Laboratories.
- ** Manufactured under license under U.S. Patent No's: 5,956,674, 5,974,380, 5,978,762, 6,487,535, 6,226,616, 7,212,872, 7,003,467, 7,272,567, 7,668,723, 7,392,195, 7,333,929, 7,548,853 & other U.S. and worldwide patents issued and pending. DTS-HD, the Symbol, & DTS-HD and the Symbol together are registered trademarks & DTS-HD Master Audio is a trademark of DTS, Inc. Product includes software. © DTS, Inc. All Rights Reserved.

This receiver incorporates High-Definition Multimedia Interface (HDMI™) technology.

HDMI, the HDMI logo and High-Definition Multimedia Interface are trademarks or registered trademarks of HDMI Licensing LLC.

Hardware and subscription sold separately. SiriusXM service automatically renews and you will be billed, at then-current rates, until you call us at 1-866-635-2349 to cancel. See our Customer Agreement for complete terms at www.siriusxm.com. Sirius, XM and all related marks and logos are trademarks of Sirius XM Radio Inc. All rights reserved.

The font type (Shin Go R) installed in this receiver is provided by MORISAWA & COMPANY LTD. These names are the trademarks of MORISAWA & COMPANY LTD., and the copyright of the font also belongs to MORISAWA & COMPANY LTD.

iPhone, iPod, iPod classic, iPod nano, and iPod touch are trademarks of Apple Inc., registered in the U.S. and other countries.

All other trademarks and registered trademarks are of their respective holders. In this manual, ™ and ® marks are not specified.



“Made for iPod,” and “Made for iPhone” mean that an electronic accessory has been designed to connect specifically to iPod or iPhone, respectively, and has been certified by the developer to meet Apple performance standards. Apple is not responsible for the operation of this device or its compliance with safety and regulatory standards. Please note that the use of this accessory with iPod or iPhone may affect wireless performance.

DLNA and DLNA CERTIFIED are trademarks and/or service marks of the Digital Living Network Alliance.

MPEG Layer-3 audio coding technology and patents licensed from Fraunhofer IIS and Thomson.

“BRAVIA” Sync is a trademark of Sony Corporation.

“x.v.Color” and “x.v.Color” logo are trademarks of Sony Corporation.

“PlayStation®” is a registered trademark of Sony Computer Entertainment Inc.

“AVCHD” and the “AVCHD” logo are trademarks of Panasonic Corporation and Sony Corporation.

Windows Media is either a registered trademark or trademark of Microsoft Corporation in the United States and/or other countries.

This product contains technology subject to certain intellectual property rights of Microsoft. Use or distribution of this technology outside of this product is prohibited without the appropriate license(s) from Microsoft.

Content owners use Microsoft PlayReady™ content access technology to protect their intellectual property, including copyrighted content. This device uses PlayReady technology to access PlayReady-protected content and/or WMDRM-protected content. If the device fails to properly enforce restrictions on content usage, content owners may require Microsoft to revoke the device's ability to consume PlayReady-protected content. Revocation should not affect unprotected content or content protected by other content access technologies. Content owners may require you to upgrade PlayReady to access their content. If you decline an upgrade, you will not be able to access content that requires the upgrade.

“WALKMAN” and “WALKMAN” logo are registered trademarks of Sony Corporation.

“Android” is a registered trademark or a trademark of Google Inc.

Main features of the receiver

Compatible with a variety of connections and formats

Feature	Description	Page
Multi-channel	The receiver can output up to 9.1 channels. The receiver is equipped with speaker terminals for the front height channel. (Up to 7 channels can be output simultaneously with connected speakers.)	24, 26
Compatible with various standards	The receiver is compatible with various audio formats, such as Dolby TrueHD, DTS-HD Master Audio, DSD, multi-channel Linear PCM, FLAC, etc.	23
HDMI	The receiver is equipped with five HDMI input jacks (of which two HDMI IN 3 and IN 4 are the "for AUDIO" jacks which take sound quality into account) on the back panel, and one HDMI jack on the front panel. You can connect various equipment using an HDMI connection.	28, 30, 32, 34
	The receiver is compatible with various HDMI standards, such as Deep Color, x.v.Color, 3D transmission, Audio Return Channel (ARC), etc.	38, 88
	You can operate the receiver and other equipment in conjunction with each other using the Control for HDMI function.	84
Network	The receiver is equipped with four LAN ports that have switching hub functions.	46
	The receiver is compatible with Internet video streaming.	57
	The receiver allows you to play back content on a home network via the DLNA-compliant home network function.	61
USB	You can easily play back iPhone/iPod content via the receiver using a USB connection.	56, 60
	You can easily play back content on USB device/WALKMAN via the receiver using a USB connection.	55
Multi-zone	You can enjoy music or video from other rooms.	78

Better image and sound quality

Feature	Description	Page
Image up-conversion	The receiver upscales or downscales analog video signals. The signals can be upscaled to 1080p using an HDMI output jack. The receiver also upscales or downscales analog video signals for zone 2.	22
D.C.A.C.	The receiver is equipped with the D.C.A.C. (Digital Cinema Auto Calibration) function. Additionally, the receiver compensates sound output for each speaker and improves surround effects via the Speaker Relocation function and the A.P.M. (Automatic Phase Matching) function.	101, 103

Feature	Description	Page
Sound fields	The receiver creates optimum sound in accordance with various speaker connections or input sources. (The receiver's preprogrammed sound fields are Dolby Pro Logic IIz, DTS Neo:X, HD-D.C.S., etc.)	72, 74
High quality reproduction of compressed audio files	You can play back compressed audio files in high quality using the D.L.L. (Digital Legato Linear) function.	107
H.A.T.S.	The H.A.T.S. (High quality digital Audio Transmission System) function transmits signals from a Super Audio CD player connected via an HDMI connection in high quality.	113

Useful functions

Feature	Description	Page
Easy and accessible operations	The receiver is equipped with a GUI (Graphical User Interface). You can operate the receiver intuitively using a menu displayed on the TV screen.	52
	You can set the basic settings of the receiver easily using the Easy Setup.	49
	A multifunction remote control for operating connected equipment and the Multi-zone function, and a simple remote control performing normal operations are supplied with the receiver.	17
	You can recall various settings of the receiver all at one time with the press of the EASY AUTOMATION button.	91
Flexible functions	The Sound Optimizer function optimizes audio output in accordance with the volume level.	76
	The Advanced Auto Volume function adjusts the volume to its optimum level automatically.	77
	The A/V Sync function adjusts the time gap between audio output and the visual display.	108
	The Pass Through function outputs HDMI signals to the TV even when the receiver is in standby mode.	87

Others

Feature	Description	Page
Environment-friendly function	The Auto Standby function switches the receiver to standby mode automatically if you do not operate the receiver for a specific period of time or when there is no signal input to the receiver.	118
More useful	You can operate the receiver using a smartphone equipped with "ES Remote" application software*. * Compatible with iPhone/iPod touch and Android phone	91

Table of Contents

Main features of the receiver	6
Description and location of parts	10

Getting Started

Read the following before you connect any equipment	21
1: Installing speakers	24
2: Connecting the monitor	28
3: Connecting the video equipment	30
4: Connecting the audio equipment	39
5: Connecting to the network	45
6: Preparing the receiver and the remote control	47
7: Setting up the receiver using the Easy Setup	49
8: Setting up connected equipment	51
9: Preparing a computer to use as a server ..	51
Guide to on-screen display operation	52

Enjoying images/sound

Enjoying images/sound from the connected equipment	54
USB Device/WALKMAN	55
iPhone/iPod	56
DLNA	57
Internet video	57
FM/AM	59
SIRIUS	59

Enjoying an iPhone/iPod

Playing files on an iPhone/iPod	60
---------------------------------------	----

Playing via a Network

Playing files on a home network (DLNA)	61
--	----

Tuning

Listening to FM/AM radio	62
Listening to the satellite radio	64
Connecting a satellite radio tuner	65
Preparing to listen to the satellite radio	65
Selecting a channel of the satellite radio ...	66
Presetting satellite radio channels	67
Restricting access to specific channels (Parental Lock)	68

Enjoying Sound Effects

Selecting the sound field	71
Using the Sound Optimizer function	76
Adjusting the equalizer	77
Using the Advanced Auto Volume function	77

Using Multi-zone Features

What you can do with the Multi-zone function	78
Making a multi-zone connection	78
Setting the speakers in zone 2	81
Switching the zone setting of the remote control	81
Operating the receiver from another zone (ZONE 2/ZONE 3 operations)	82

Using Other Features

Using “BRAVIA” Sync features	84
Switching the monitors that output the HDMI video signals	86
Outputting the HDMI signals even when the receiver is in standby mode (Pass Through)	87
Switching between digital and analog audio	88
Using other video/audio input jacks	88

Operating the receiver using a smartphone	91
Saving various settings for the receiver and recalling those settings all at one time (Easy Automation)	91
Using the sleep timer	94
Recording using the receiver	94
Switching the command mode of the receiver and the remote control	95
Using a bi-amplifier connection	97

Additional Information

Precautions	137
Troubleshooting	138
Specifications	149
Index	153

Adjusting Settings

Using the setting menu	98
Easy Setup	101
Speaker Settings	101
Audio Settings	107
Video Settings	109
HDMI Settings	112
Input Settings	114
Network Settings	115
Internet Services Settings	115
Zone Settings	116
System Settings	118
Network Update	119
Operating without using the GUI	119

Using the Remote Control

Operating each equipment using the remote control	127
Turning off all connected equipment (SYSTEM STANDBY)	128
Programming the remote control	128
Performing several commands in sequence automatically (Macro Play)	132
Setting remote control codes that are not stored in the remote control	133
Clearing the memory of the multifunction remote control	135

Description and location of parts

Front panel

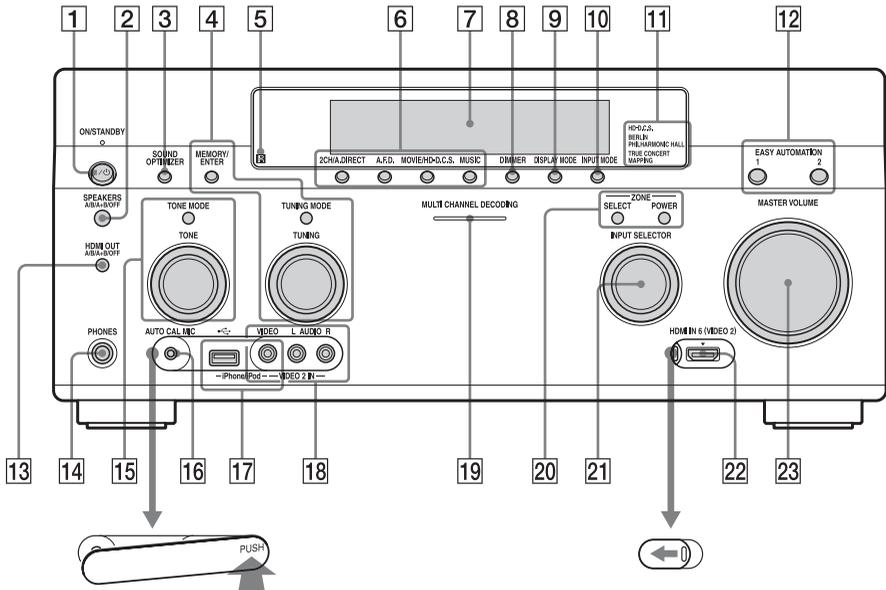

To remove the cover

Press PUSH.

When you remove the cover, keep it out of reach from children.

To open the cover

Slide the cover to the left.

1 I/O ON/STANDBY

Press to turn the receiver on or off. When the power is on, the lamp above the button lights up in green. If “Control for HDMI” (page 113), “Pass Through” (page 113), or “Network Standby” (page 115) is set to “On,” or the power for zone 2 or zone 3 is turned on, the lamp above the button lights up in amber when in the standby mode.

2 SPEAKERS (A/B/A+B/OFF) (page 50)

3 SOUND OPTIMIZER (page 76)

4 MEMORY/ENTER, TUNING MODE, TUNING (page 62)

5 Remote sensor

Receives signals from remote control.

6 2CH/A.DIRECT, A.F.D., MOVIE/HD-D.C.S., MUSIC (page 71, 72, 72, 74)

7 Display window (page 12)

8 DIMMER

Press repeatedly to adjust brightness of the display window.

9 DISPLAY MODE (page 126)

10 INPUT MODE (page 88)

- 11 HD-D.C.S. lamp, BERLIN PHILHARMONIC HALL lamp, TRUE CONCERT MAPPING lamp (page 72)**
- 12 EASY AUTOMATION 1, 2 (page 91)**
- 13 HDMI OUT (A/B/A+B/OFF) (page 86)**
- 14 PHONES jack**
Connects to headphones.
- 15 TONE MODE, TONE**
Press TONE MODE repeatedly to select BASS or TREBLE, then turn TONE to adjust the bass/treble level of speakers.
- 16 AUTO CAL MIC jack (page 101)**
Connect the supplied optimizer microphone for “Auto Calibration” to the this jack.
- 17 iPhone/iPod (⌘ (USB) port and VIDEO IN jack) (page 55, 56, 60)**
- 18 VIDEO 2 IN jacks (page 37)**
- 19 MULTI CHANNEL DECODING lamp**
Lights up when multi-channel audio signals are decoded.
- 20 ZONE SELECT, POWER (page 78)**
Press SELECT repeatedly to select zone 2, zone 3 or main zone. Each time you press POWER, the output signals for the selected zone will be turned on or off.
- 21 INPUT SELECTOR**
Turn to select the input source to play back.
To select the input source for zone 2 or zone 3, press ZONE SELECT (**20**) to select zone 2 or zone 3 first (“ZONE 2 [input name]” or “ZONE 3 [input name]” appears on the display window), then turn INPUT SELECTOR to select the input source.
- 22 HDMI IN 6 (VIDEO 2) jack (page 38)**
- 23 MASTER VOLUME (page 54)**

Indicators on the display

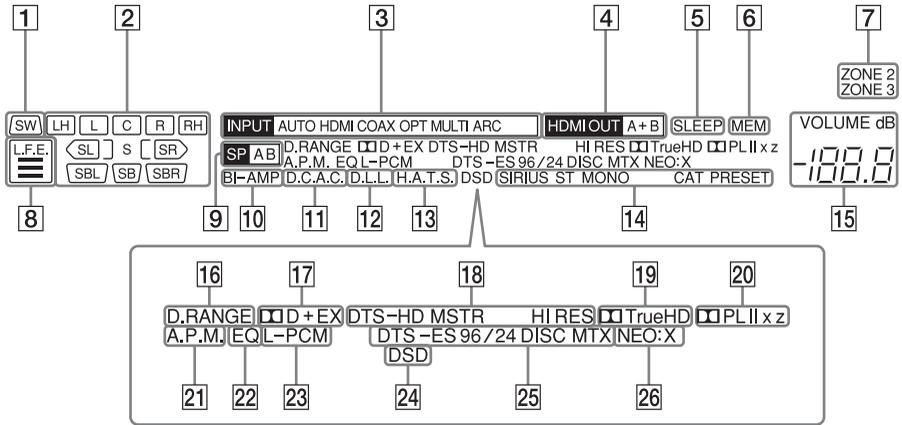

1 SW

Lights up when subwoofer(s) is (are) connected and the audio signal is output from the PRE OUT SUBWOOFER jack(s).

2 Playback channel indicator

The letters (L, C, R, etc.) indicate the channels being decoded. Based on the speaker settings, the boxed letter(s) vary to show how the receiver downmixes or upmixes the source sound.

L

Front Left

R

Front Right

C

Center (monaural)

LH

Left High

RH

Right High

SL

Surround Left

SR

Surround Right

S

Surround (monaural or the surround equipment obtained by Pro Logic processing)

SBL

Surround Back Left

SBR

Surround Back Right

SB

Surround Back (the surround back equipment obtained by 6.1 channel decoding)

Example:

Recording format: 5.1

Speaker pattern: 3/0.1

Sound Field: A.F.D. Auto



3 INPUT indicator

Lights up to indicate the current input.

AUTO

The INPUT MODE is set to "AUTO."

HDMI

COAX

OPT

MULTI (MULTI CHANNEL INPUT)

ARC (page 88)

4 HDMI OUT A + B (page 86)

5 SLEEP (page 94)

6 MEM

Lights up when the preset memory function is activated.

7 ZONE 2/ZONE 3 (page 78)

8 L.F.E.

Lights up when the disc being played back contains an L.F.E. (Low Frequency Effects) channel. The L.F.E. channel signal is actually being reproduced, the bars underneath the letters light up to indicate the level. Since the L.F.E. signal is not recorded in all parts of the input signal, the bar indication will fluctuate (and may turn off) during playback.

9 Speaker system indicator (page 50)

10 BI-AMP (page 97)

11 D.C.A.C. (page 101)

Lights up when the measurement results of the "Auto Calibration" function are applied.

12 D.L.L. (page 107)

13 H.A.T.S. (page 113)

14 Tuning indicator

Lights up when the receiver tunes to a radio station, or a satellite station.

SIRIUS (page 64)

ST

Stereo reception

MONO

FM mode is set to the monaural mode.

CAT

The category mode is selected during the satellite radio operation.

PRESET

The tuning mode is set to the preset mode.

15 VOLUME

Displays the current volume.

16 D.RANGE

Lights up when dynamic range compression is activated.

17 Dolby Digital Surround indicator

Lights up with one of the respective indicators when the receiver is decoding the corresponding Dolby Digital format signals.

DD

Dolby Digital

DD+

Dolby Digital Plus

DD EX

Dolby Digital Surround EX

18 DTS-HD indicator

Lights up when the receiver is decoding DTS-HD.

DTS-HD

Lights up constantly with the one of the following indicators.

MSTR

DTS-HD Master Audio

HI RES

DTS-HD High Resolution Audio

19 DD TrueHD

Lights up when the receiver is decoding Dolby TrueHD.

20 Dolby Pro Logic indicator

Lights up with one of the respective indicators when the receiver performs Dolby Pro Logic processing. This matrix surround decoding technology can enhance input signals.

DD PL

Dolby Pro Logic

DD PL II

Dolby Pro Logic II

DD PL IIx

Dolby Pro Logic IIx

DD PL IIz

Dolby Pro Logic IIz

21 A.P.M. (page 103)

Lights up when the A.P.M. (Automatic Phase Matching) function is activated.

22 EQ

Lights up when the equalizer is activated.

23 L-PCM

Lights up when Linear PCM (Pulse Code Modulation) signals are input.

24 DSD

Lights up when the receiver is receiving DSD (Direct Stream Digital) signals.

25 DTS(-ES) indicator

Lights up when DTS or DTS-ES signals are input.

DTS

Lights up when the receiver is decoding DTS signals.

DTS-ES

Lights up with the either following indicator, depending on the input signal decoding format.

96/24

DTS 96/24 (96 kHz/24 bit) decoding

DISC

DTS-ES Discrete 6.1

MTX

DTS-ES Matrix 6.1

26 **NEO:X**

Lights up when DTS Neo:X Cinema/Music/Game decoding is activated.

Rear panel

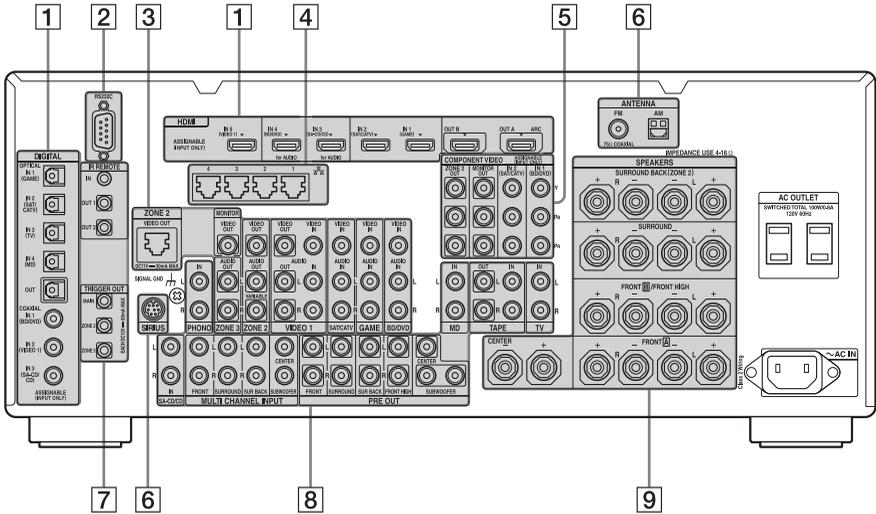

1 DIGITAL INPUT/OUTPUT section

 **OPTICAL IN/OUT jacks**
(page 28, 32, 34, 42)

 **COAXIAL IN jacks**
(page 31, 39)

 **HDMI IN/OUT* jacks**
(page 28, 30, 32, 34)

2 RS232C port



Used for maintenance and service.

3 VIDEO/AUDIO INPUT/OUTPUT section (page 28, 31, 32, 34, 36)

 **AUDIO IN/OUT jacks**

 **VIDEO IN/OUT* jacks**



AUDIO OUT jacks
VIDEO OUT jack
(page 78)



ZONE 2 VIDEO OUT jack
(page 80)

An RJ-45 jack used to send a video signal to the equipment in zone 2. Use a CAT5 cable for the connection. Used for custom installation. For information on how to use this jack, consult your dealer.

Attention

Do not use this jack for an Ethernet LAN connection. Doing so may cause a malfunction.

continued

**4 LAN ports (switching hubs)
(page 46)**



**5 COMPONENT VIDEO INPUT/
OUTPUT section (page 28, 31, 34)**



Y, P_B, P_R IN/OUT* jacks

6 ANTENNA section



**FM ANTENNA jack
(page 43)**



**AM ANTENNA jack
(page 43)**



SIRIUS jack (page 65)

**7 Control jacks for Sony equipment
and other external equipment**



**IR REMOTE IN/OUT
jacks (page 78)**

Connect an IR repeater (not supplied) to use the Multi-zone function.



**TRIGGER OUT jacks
(page 117)**

Connect to interlock on/off of the power supply of other 12V TRIGGER compliant equipment.

8 AUDIO INPUT/OUTPUT section



**AUDIO IN/OUT jacks
(page 39, 42, 44)**



**MULTI CHANNEL INPUT
jacks (page 31, 39)**



PRE OUT jacks

Connect to an external power amplifier.

9 SPEAKERS section (page 26)

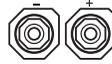

* You must connect the HDMI OUT or MONITOR OUT jack to your TV to watch the selected input image (page 28).

Remote control

Use the supplied remote control to operate this receiver and other equipment. The remote control is pre-programmed to operate Sony video/audio equipment initially.

Note

Do not expose the remote sensor to direct sunlight or lighting apparatuses. Doing so may cause a malfunction.

Tip

When the receiver no longer responds to the remote control, replace all the batteries with new ones.

Multifunction remote control (RM-AAL040)

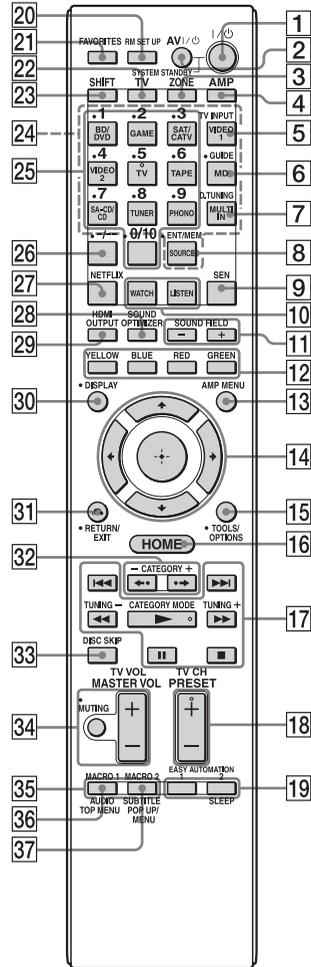

- 1 **I/⏻ (on/standby)**
Press to turn the receiver on or off.
- 2 **AV I/⏻ (on/standby)**
Press to turn on or off the video/audio equipment that the remote is assigned to operate.
- 3 **ZONE (page 78)**
- 4 **AMP**
Press to enable the receiver operation for main zone.

continued

5 TV INPUT

Press TV (22), then press TV INPUT to select the input signal of a TV.

6 GUIDE

Press SHIFT (23), then press GUIDE to display the on-screen program guide.

7 D.TUNING (page 62, 67)

Press SHIFT (23), then press to enter direct tuning mode.

8 ENT/MEM

Press to enter the value or track using SHIFT (23) and the numeric buttons (25), or press ENT/MEM, then press the numeric buttons (24) to select a preset number to which a station is stored during tuner operation.

9 SEN

Press to go to the home page of the Sony Entertainment Network, a network service provided by Sony.

10 WATCH, LISTEN (page 54)

11 SOUND FIELD +/- (page 71, 72, 74, 72)

12 Color buttons

Work according to the guide on the TV screen.

13 AMP MENU (page 119)

14 (+) ↑/↓/←/→

Press ↑/↓/←/→ to select the menu items. Then press (+) to enter the selection.

15 TOOLS/OPTIONS (page 52, 58, 64)

Press to display and select items from option menus.

16 HOME (page 52)

Press to display the home menu on the TV screen.

17 ◀◀/▶▶ 1), ■ 1), || 1), ▶▶ 1) 2), ◀◀/▶▶ 1)

Press to operate the DVD player, Blu-ray Disc Player, CD player, MD deck, tape deck, equipment connected to the ↔ (USB) port or to the network, or BRAVIA Internet Video, etc.

CATEGORY MODE

Press to select the category mode for satellite tuner.

TUNING +/-

Press to select station.

18 PRESET + 2)/-

Press to select preset stations.

TV CH + 2)/-

Press TV (22), then press TV CH +/- to operate the TV, satellite tuner, etc.

19 EASY AUTOMATION 1, 2 (page 91) SLEEP (page 94)

20 RM SET UP (page 95)

21 FAVORITES (page 58)

22 TV

Press to change the remote control button function to the one printed in yellow to enable the TV operation.

23 SHIFT

Press to change the remote control button function to activate the buttons printed in pink.

24 Input buttons

Press one of the buttons to select the equipment you want to use. When you press any of the input buttons, the receiver turns on.

25 Numeric buttons

Press SHIFT (23), then press to input numbers.

Press TV (22), then press to select channel numbers of the TV.

26 -/--

Press SHIFT (23), then press to
– select track numbers over 10 of the CD player, DVD player, Blu-ray Disc Player, or MD deck.
– select channel numbers over 10 of the TV, Satellite tuner or the VCR.

27 NETFLIX

Press to go to the home page of the Netflix service. Netflix unlimited membership required.

28 SOUND OPTIMIZER (page 76)

29 HDMI OUTPUT (page 86)

30 DISPLAY

Press to display the control panel on the TV screen when playing back content via Internet video or a home network.

31 RETURN/EXIT ↶

Press to return to the previous menu or exit the menu.

32 CATEGORY +/-

Press to select the category for satellite tuner.



Press to select an album.

33 DISC SKIP

Press to skip a disc when using a multi-disc changer.

34 MASTER VOL +/- (page 54)

TV VOL

After pressing TV (22), you can also adjust and mute the volume level of the TV using these buttons.

MUTING (page 54)

35 MACRO 1, MACRO 2 (page 132)

36 TOP MENU

Opens or closes the BD-ROM's or DVD's Top Menu.

AUDIO

Press SHIFT (23), then press AUDIO to select audio format/track.

37 POP UP/MENU

Opens or closes the BD-ROM's Pop-up Menu, or the DVD's menu.

SUBTITLE

Press SHIFT (23), then press to select the subtitle language when multilingual subtitles are recorded on a BD-ROM/ DVD VIDEO.

Note

The above explanation is intended to serve as examples.

¹⁾See the table on page 127 for information on the buttons that you can use to control each equipment.

²⁾The tactile dot is attached to these buttons (5/TV, ►, PRESET +/-TV CH +). Use as a mark of operation.

Simple remote control (RM-AAU124)

This remote control can only be used to operate the receiver. You can control the main functions of the receiver with simple operations using this remote control.

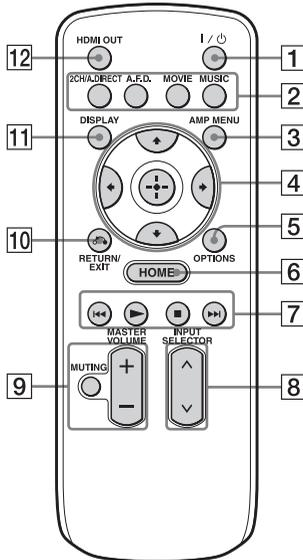

- 8 **INPUT SELECTOR**
- 9 **MASTER VOLUME +/- (page 54)**
MUTING (page 54)
- 10 **RETURN/EXIT ↶ (page 52)**
- 11 **DISPLAY**
Press to display the control panel on the TV screen when playing back content via Internet video or a home network.
- 12 **HDMI OUT (page 86)**

- 1 **I/O (on/standby)**
Press to turn a receiver on or off.
- 2 **2CH/A.DIRECT, A.F.D., MOVIE, MUSIC (page 71, 72, 74)**
- 3 **AMP MENU (page 119)**
- 4 **⊕/⊖** **↑/↓/←/→**
Press **↑/↓/←/→** to select the menu item.
Then press **⊕/⊖** to enter/confirm the selection.
- 5 **OPTIONS (page 52, 58, 64)**
- 6 **HOME (page 52)**
- 7 **▶, ■, ◀◀/▶▶**
Press to operate the equipment connected to the front ◀◀-(USB) port or to the network, or Internet video, etc.

Read the following before you connect any equipment

Before connecting cords, make sure to disconnect the AC power cord (mains lead).

Installing Speakers

See "1: Installing speakers" (page 24).



Connecting the monitor and video equipment

The image quality depends on the connecting jack. See the illustration on the right. Select the connection according to the jacks on your equipment.

The receiver has a video conversion function. For details, see "Function for conversion of video signals" (page 22).

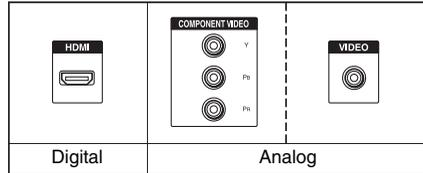

Q: Does your monitor have an HDMI jack?

- **No:** See the connection for a TV monitor without an HDMI jack in "2: Connecting the monitor" (page 28) and "3: Connecting the video equipment" (page 30).
- **Yes:** See the connection for a TV monitor with an HDMI jack in "2: Connecting the monitor" (page 28) and "3: Connecting the video equipment" (page 30).



Connecting the audio equipment

See "4: Connecting the audio equipment" (page 39).



Preparing the receiver and the remote control

See "6: Preparing the receiver and the remote control" (page 47).



Setting the receiver

See "7: Setting up the receiver using the Easy Setup" (page 49).



Setting the audio output settings on the connected equipment

See "8: Setting up connected equipment" (page 51).

For details on a multi-zone connection, see page 78.

For details on a bi-amplifier connection, see page 97.

Function for conversion of video signals

This receiver is equipped with a function for converting video signals.

- Composite video signals can be output as HDMI video and component video signals.
- Component video signals can be output as HDMI video and video signals.

As the factory default setting, video signals input from the connected equipment are output to the HDMI OUT or MONITOR OUT jacks as shown in the table below.

We recommend you set the video conversion function to match the resolution of the monitor you are using.

For details on the video converting function, see “Video Settings” (page 109).

OUTPUT jack INPUT jack	HDMI OUT A/B (up to 1080p)	COMPONENT VIDEO MONITOR OUT (up to 1080i)	MONITOR VIDEO OUT	VIDEO 1 OUT
HDMI IN	○	—	—	—
VIDEO IN	○	○*	○*	○
COMPONENT VIDEO IN	○	○*	○*	—

○ : Video signals are output.

— : Video signals are not output.

* Video signals may not be output, depending on the setting in “Resolution” (page 109).

Note on converting video signals

Video signals for which the resolution has been converted may not be output from the COMPONENT VIDEO MONITOR OUT jacks or the HDMI OUT jacks simultaneously. If you connect equipment to both the COMPONENT VIDEO MONITOR OUT jacks and the HDMI OUT jacks, priority is given to the output from the HDMI OUT jacks.

To connect a recording equipment

When recording, connect the recording equipment to the VIDEO OUT jacks of the receiver. Connect cords for input and output signals to the same type of jack, as VIDEO OUT jacks do not have an up-conversion function.

The HDMI OUT and the MONITOR OUT jacks cannot be used for recording.

To display Closed Caption

Set “Resolution” to “Direct” in the Video Settings menu when receiving a signal that supports Closed Captions.

Use the same kind of cords for the input/output signals.

Digital audio formats supported by the receiver

Digital audio formats that this receiver can decode depend on digital audio input jacks of the equipment connected.

This receiver supports the following audio formats.

Audio format	Maximum number of channels	Connection between the playback equipment and the receiver	
		COAXIAL/OPTICAL	HDMI
Dolby Digital 	5.1ch	○	○
Dolby Digital EX 	6.1ch	○	○
Dolby Digital Plus* 	7.1ch	×	○
Dolby TrueHD* 	7.1ch	×	○
DTS 	5.1ch	○	○
DTS-ES 	6.1ch	○	○
DTS 96/24 	5.1ch	○	○
DTS-HD High Resolution Audio* 	7.1ch	×	○
DTS-HD Master Audio* 	7.1ch	×	○
DSD* 	5.1ch	×	○
Multi-Channel Linear PCM*	7.1ch	×	○

* Audio signals are output in another format if the playback equipment does not correspond to the format. For details, refer to the operating instructions of the playback equipment.

1: Installing speakers

This receiver allows you to use up to a 9.1 channel system (9 speakers and one subwoofer).

Examples of speaker system configuration

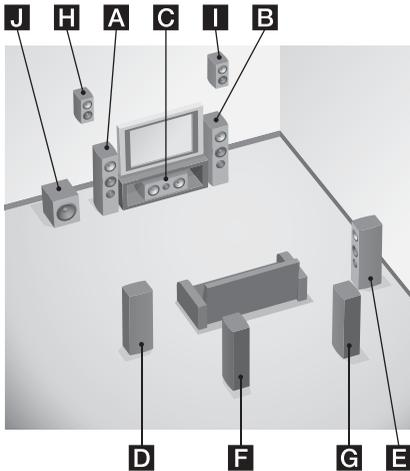

9.1 channel speaker system

You can enjoy high-quality multi-channel surround sound maximally just you would in an ideal dubbing theater.

- A** Front left speaker
- B** Front right speaker
- C** Center speaker
- D** Surround left speaker
- E** Surround right speaker
- F** Surround back left speaker
- G** Surround back right speaker
- H** Left high speaker
- I** Right high speaker
- J** Subwoofer

7.1 channel speaker system using surround back speakers

You can enjoy high fidelity reproduction of DVD or Blu-ray Disc software recorded sound in 6.1 channel or 7.1 channel format.

- A** Front left speaker
- B** Front right speaker
- C** Center speaker
- D** Surround left speaker
- E** Surround right speaker
- F** Surround back left speaker
- G** Surround back right speaker
- J** Subwoofer

7.1 channel speaker system using front high speakers

You can enjoy vertical sound effects (e.g., Pro Logic IIz mode, Neo:X mode).

- A** Front left speaker
- B** Front right speaker
- C** Center speaker
- D** Surround left speaker
- E** Surround right speaker
- H** Left high speaker
- I** Right high speaker
- J** Subwoofer

5.1 channel speaker system

To fully enjoy theater-like multi-channel surround sound requires five speakers (two front speakers, a center speaker, and two surround speakers) and a subwoofer (5.1 channel system).

- A** Front left speaker
- B** Front right speaker
- C** Center speaker
- D** Surround left speaker
- E** Surround right speaker
- J** Subwoofer

Recommended speaker placement

7.1 channel speaker system

- The angle **A** shown in the illustration should be the same.

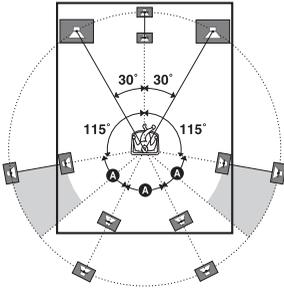

- If you cannot place the speakers at the optimum angle, separate the surround speakers and the surround back speakers adequately and arrange them as symmetrically as possible.
- You can calibrate speaker positioning using “Speaker Relocation” even if you cannot place the speakers at the optimum angle (page 103). Arrange each pair of the surround speakers and the surround back speakers spread further back than 90 degrees to operate “Speaker Relocation” effectively.
- Install the front high speakers at a position as near as possible to the wall in front of the seating position and behind the speakers. The position should be at an angle of 25 to 30 degrees and at a height of 180 to 200 cm (190 cm is recommended). When you use a screen, arrange them slightly to the side of each end of the screen.

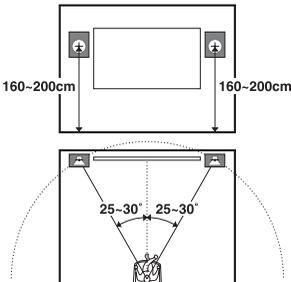

6.1 channel speaker system

- Place the surround back speaker behind the seating position.

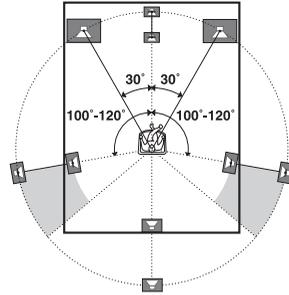

Tip

Since the subwoofer does not emit highly directional signals, you can place it wherever you want.

Connecting speakers

Before connecting cords, make sure to disconnect the AC power cord (mains lead).

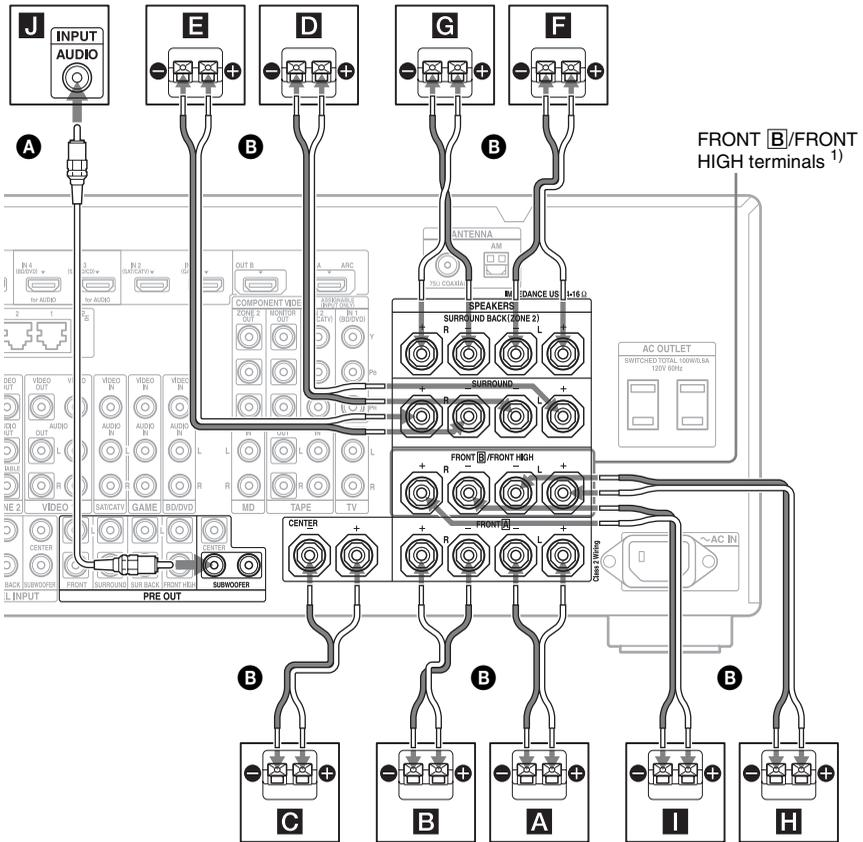

- A** Monaural audio cord (not supplied)
- B** Speaker cords (not supplied)
- A** Front speaker **A** (L)
- B** Front speaker **A** (R)
- C** Center speaker
- D** Surround speaker (L)
- E** Surround speaker (R)
- F** Surround back speaker (L)^{2) 4)}
- G** Surround back speaker (R)^{2) 4)}
- H** Front high speaker (L)^{3) 4)}
- I** Front high speaker (R)^{3) 4)}
- J** Subwoofer⁵⁾

- ¹⁾ If you have an additional front speaker system, connect them to the FRONT **B**/FRONT HIGH terminals. You can select the front speaker system you are using with SPEAKERS on the front panel (page 10).
- ²⁾ If you connect only one surround back speaker, connect it to the SURROUND BACK (ZONE 2) L terminals.
- ³⁾ If you use front high speakers, connect them to the FRONT **B**/FRONT HIGH terminals.
- ⁴⁾ You can connect both the surround back speakers and the front high speakers. However, sound cannot be output from the surround back speakers and the front high speakers simultaneously.

2: Connecting the monitor

You can watch the selected input image when you connect the HDMI OUT or MONITOR OUT jacks to a TV. You can operate this receiver using a GUI (Graphical User Interface).

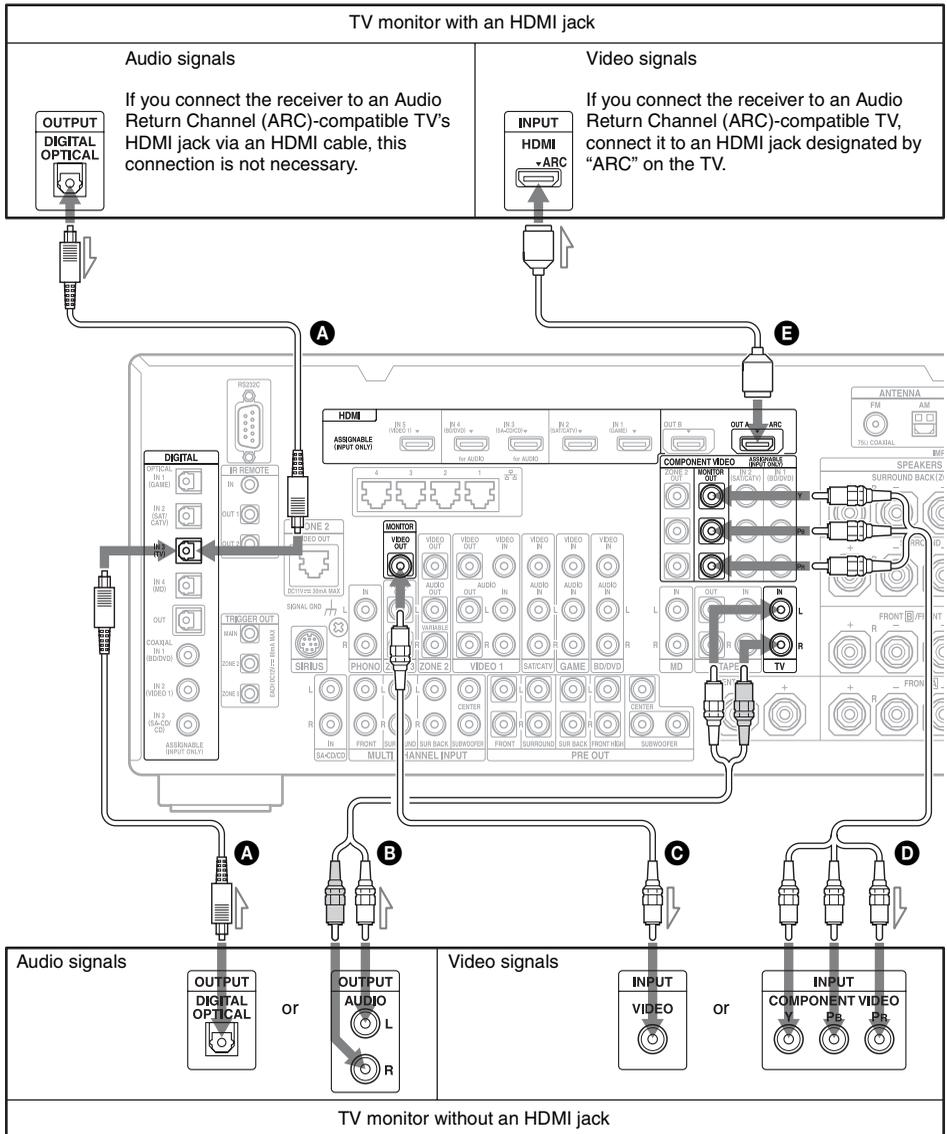

It is not necessary to connect all the cords. Connect cords according to the jacks of your equipment.

- Ⓐ Optical digital cord (not supplied)
- Ⓑ Audio cord (not supplied)
- Ⓒ Video cord (not supplied)
- Ⓓ Component video cord (not supplied)
- Ⓔ HDMI cable (not supplied)

We recommend that you use a Sony HDMI cable.

TV type	Audio Return Channel (ARC)	Required cable (cord)	
		Video	Audio
HDMI equipped	Compatible*	Ⓔ	–
	Incompatible	Ⓔ	Ⓐ or Ⓑ**
Non-HDMI equipped	–	Ⓓ or Ⓒ	Ⓐ or Ⓑ**

* You can output the TV's sound (multi-channel surround sound) from the receiver only by connecting the TV with an HDMI cable.

** If you want to output multi-channel surround sound from the receiver, use Ⓐ for the audio connection

Notes

- If you connect the TV to the receiver using video cord, set "Playback Resolution" to "480i/576i" (page 111).
- When connecting optical digital cords, insert the plugs straight until they click into place.
- Do not bend or tie optical digital cords.

Tip

The sound of the TV is output from the speakers connected to the receiver if you connect the audio output jack of the TV and the TV IN jacks of the receiver. In this configuration, set the sound output jack of the TV to "Fixed" if it can be switched between either "Fixed" or "Variable."

To connect equipment with jacks other than HDMI jacks

It is not necessary to connect all the cords. Connect cords according to the jacks of your equipment.

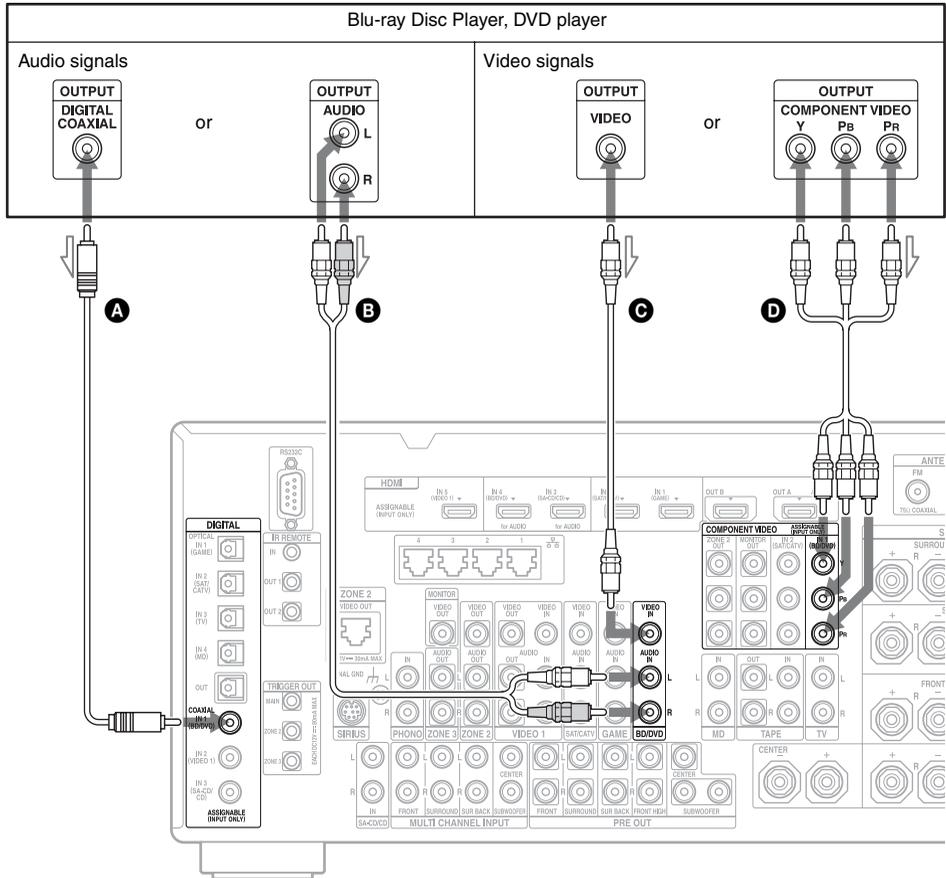

- A** Coaxial digital cord (not supplied)
- B** Audio cord (not supplied)
- C** Video cord (not supplied)
- D** Component video cord (not supplied)

Connections required for playing video games

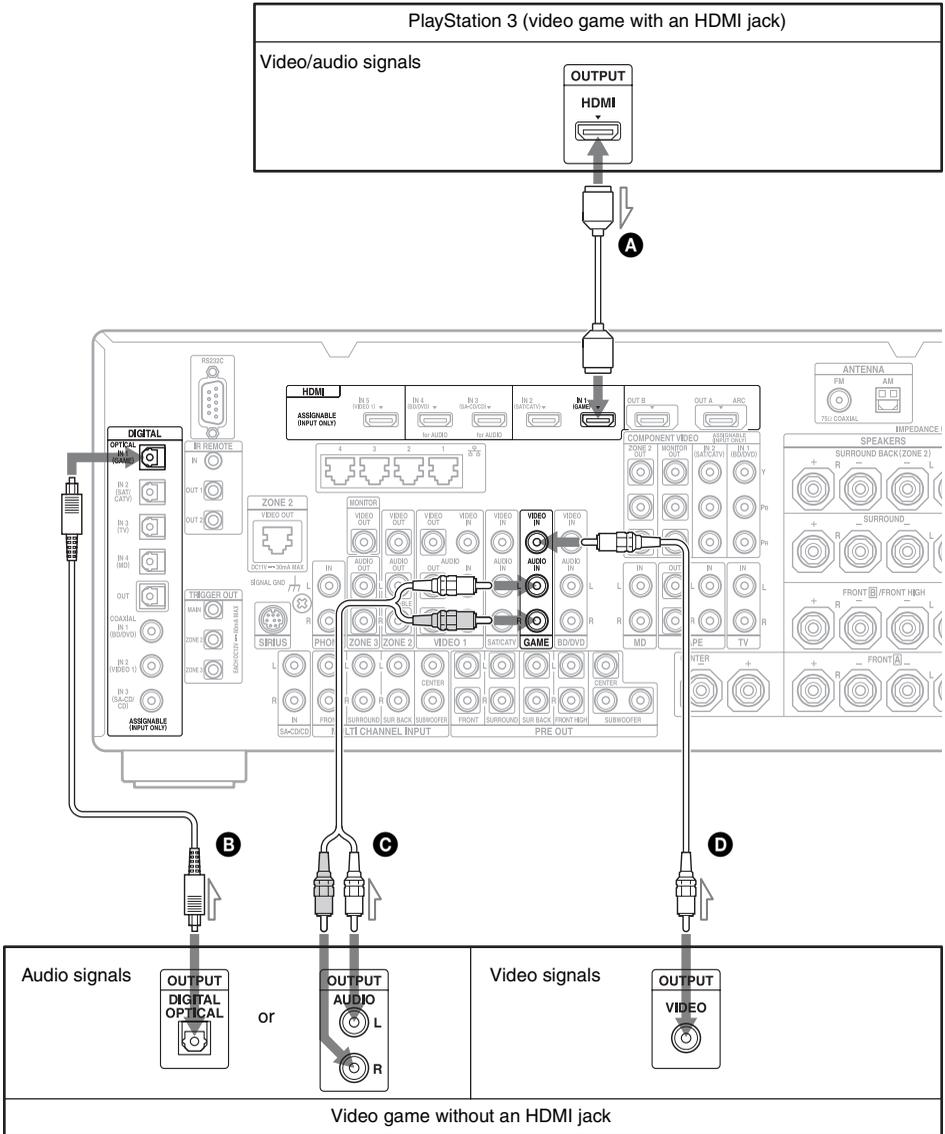

It is not necessary to connect all the cords. Connect cords according to the jacks of your equipment.

- A** HDMI cable (not supplied)
- B** Optical digital cord (not supplied)
- C** Audio cord (not supplied)
- D** Video cord (not supplied)

Video game type	Required cable (cord)	
	Video	Audio
HDMI equipped*	A	–
Non-HDMI equipped	D	B or C **

* You can output the video game's sound (multi-channel surround sound) from the receiver only by connecting the video game with an HDMI cable.

** If you want to output multi-channel surround sound from the receiver, use **B** for the audio connection

Notes

- When connecting optical digital cords, insert the plugs straight until they click into place.
- Do not bend or tie optical digital cords.

Connections required for watching programs via satellite broadcasting or via a cable TV

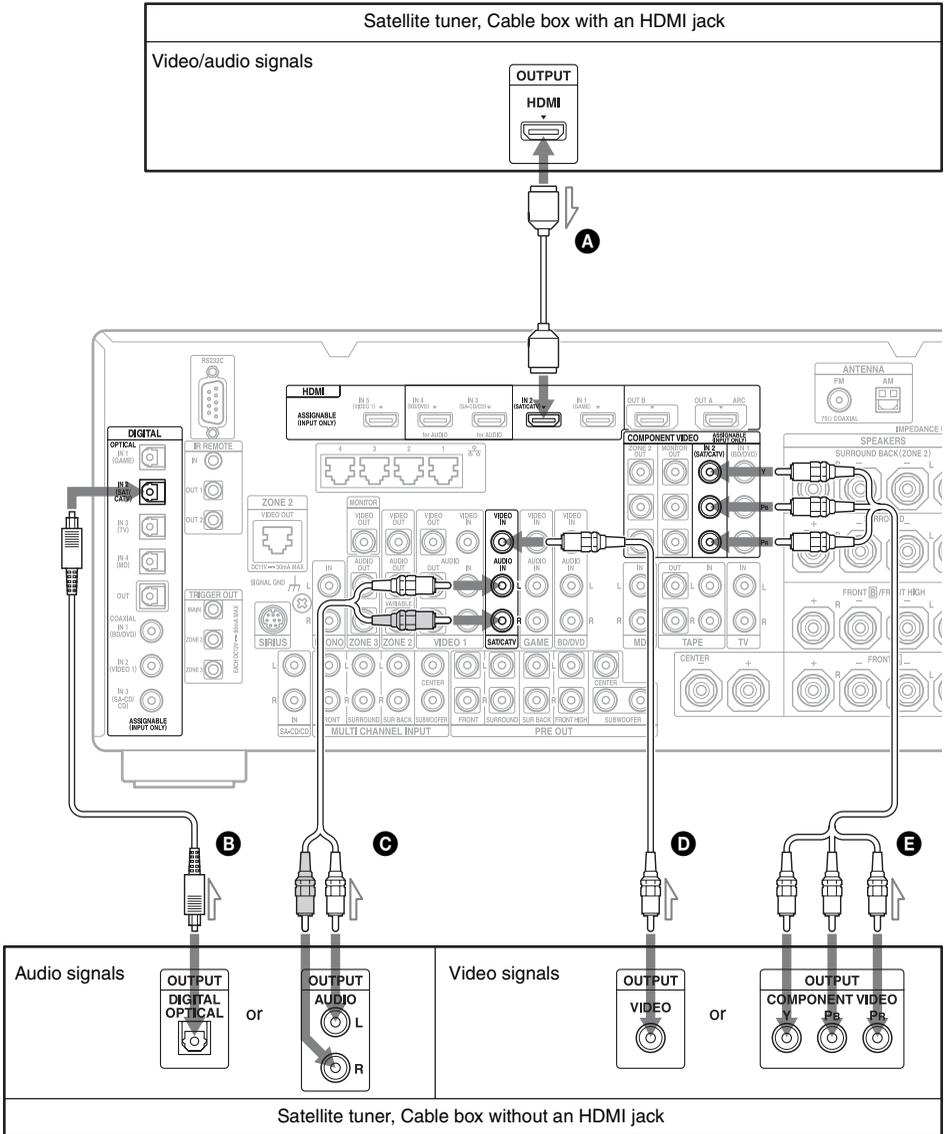

It is not necessary to connect all the cords. Connect cords according to the jacks of your equipment.

- A** HDMI cable (not supplied)
- B** Optical digital cord (not supplied)
- C** Audio cord (not supplied)
- D** Video cord (not supplied)
- E** Component video (not supplied)

Satellite tuner/cable box type	Required cable (cord)	
	Video	Audio
HDMI equipped*	A	–
Non-HDMI equipped	E or D	B or C **

* You can output the satellite tuner/cable box's sound (multi-channel surround sound) from the receiver only by connecting the satellite tuner/cable box with an HDMI cable.

** If you want to output multi-channel surround sound from the receiver, use **B** for the audio connection

Notes

- When connecting optical digital cords, insert the plugs straight until they click into place.
- Do not bend or tie optical digital cords.

Connections required for watching content recorded on video tapes

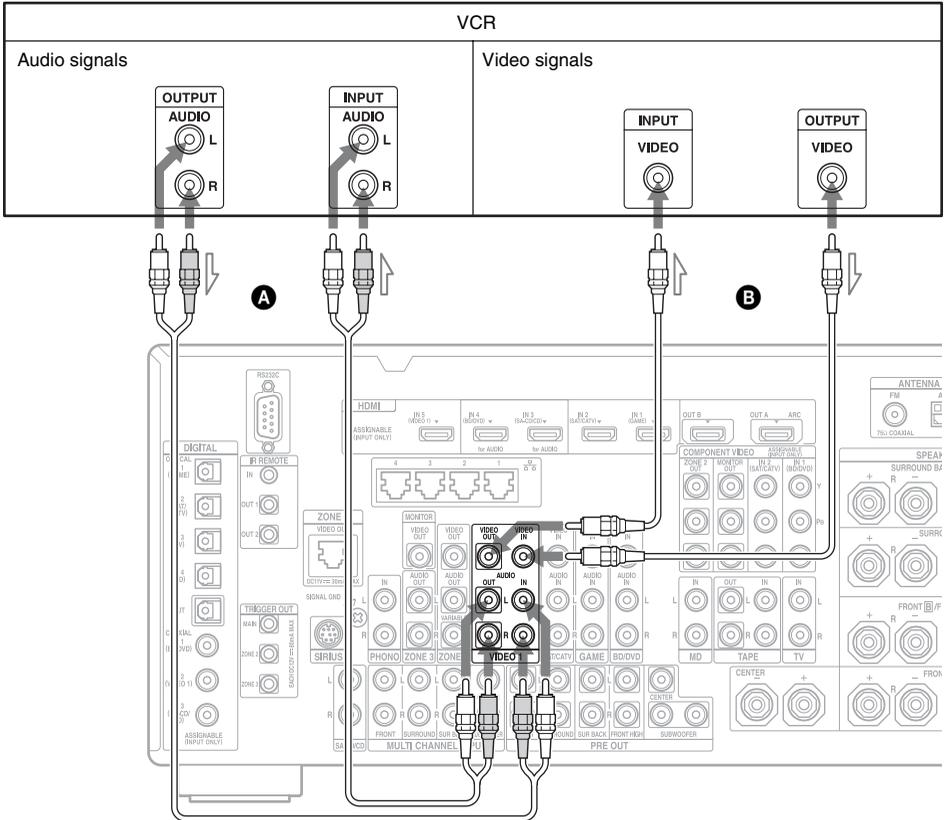

- A** Audio cord (not supplied)
- B** Video cord (not supplied)

Connections required for watching content via a camcorder

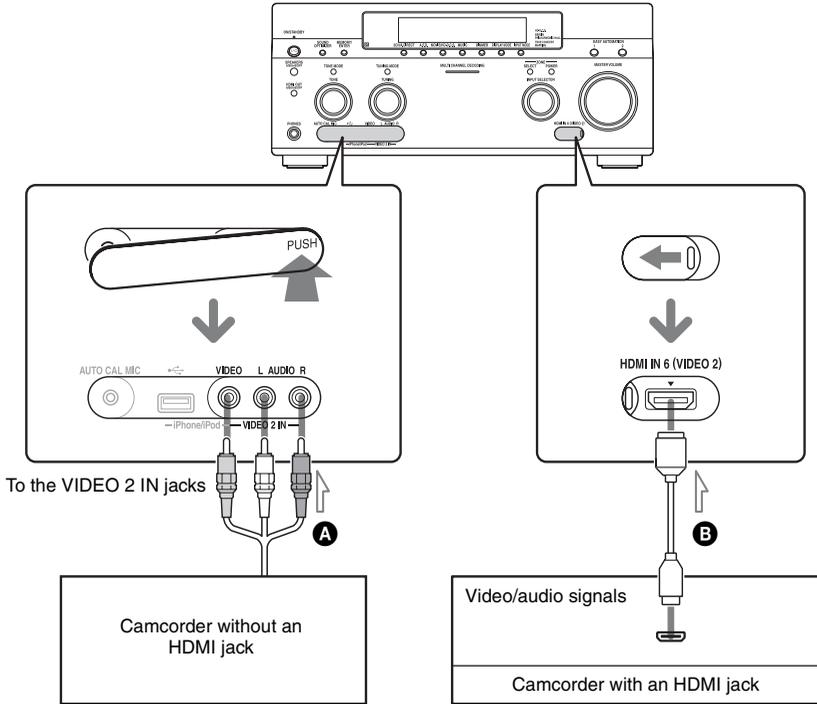

- A** Video/audio cord (not supplied)
- B** HDMI cable (not supplied)

HDMI features

- A digital audio signals transmitted by HDMI can be output from the speakers and the PRE OUT jacks on this receiver. This signal supports Dolby Digital, DTS, DSD, and Linear PCM. For details, see “Digital audio formats supported by the receiver” (page 23).
- Analog video signals input to the VIDEO jack, or COMPONENT VIDEO jacks can be output as HDMI signals. Audio signals are not output from the HDMI OUT jacks while the image is converted.
- This receiver supports High Bitrate Audio (DTS-HD Master Audio, Dolby TrueHD), Deep Color, x.v.Color and 3D transmission.
- The HDMI jacks of this receiver support the Control for HDMI function. The HDMI OUT B jack, however, does not support the Control for HDMI function.
- To enjoy 3D images, connect 3D-compatible TV and video equipment (Blu-ray Disc Player, Blu-ray Disc recorder, PlayStation 3, etc.) to the receiver using High Speed HDMI cables, put on 3D glasses, and then play back a 3D-compatible content.

Notes on connecting cables

- Use a High Speed HDMI cable. If you use a Standard HDMI cable, 1080p, Deep Color, or 3D images may not be displayed properly.
- Sony recommends that you use an HDMI-authorized cable or Sony HDMI cable.

Note on using an HDMI-DVI conversion cable

We do not recommend using an HDMI-DVI conversion cable. When you connect an HDMI-DVI conversion cable to a DVI-D equipment, the sound and/or the image may be lost. Connect separate audio cords or digital connecting cords, then set “Video Input Assign” and “Audio Input Assign” in the Input Settings menu when the sound is not output correctly.

4: Connecting the audio equipment

Connections required for listening content recorded on a Super Audio CD or ordinary CDs

If your Super Audio CD player is equipped with multi-channel output jacks, you can connect them to the MULTI CHANNEL INPUT jacks of this receiver to enjoy multi-channel sound. Alternatively, the MULTI CHANNEL INPUT jacks can be used to connect an external multi-channel decoder.

It is not necessary to connect all the cords. Connect cords according to the jacks of your equipment.

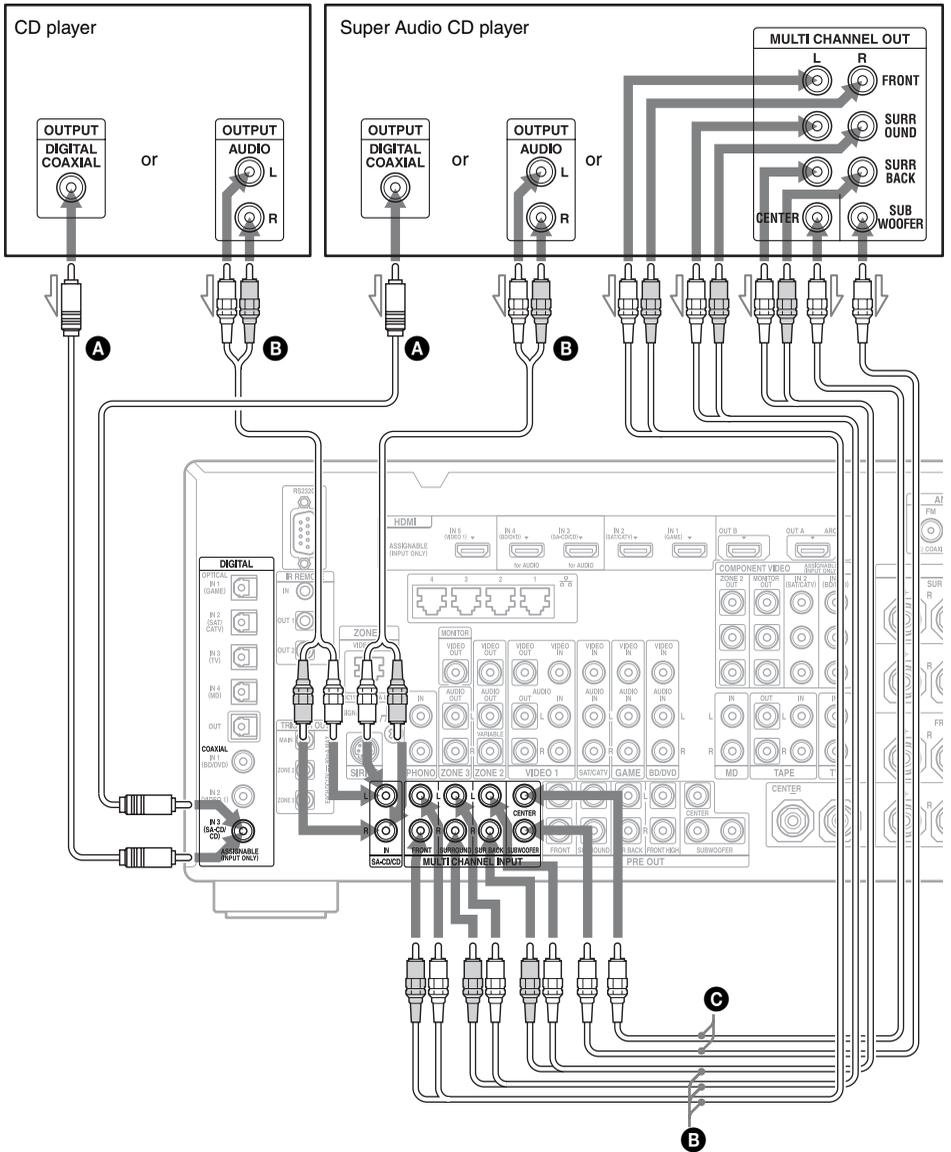

- A** Coaxial digital cord (not supplied)
- B** Audio cord (not supplied)
- C** Monaural audio cord (not supplied)

Note

Audio input signals from MULTI CHANNEL INPUT jacks cannot be recorded.

Tip

All the digital audio jacks are compatible with 32 kHz, 44.1 kHz, 48 kHz, 88.2 kHz and 96 kHz sampling frequencies. The COAXIAL IN jacks are also compatible with 192 kHz sampling frequency.

Note on playing a Super Audio CD on a Super Audio CD player

No sound is output when playing a Super Audio CD on a Super Audio CD player connected to only the COAXIAL SA-CD/CD IN jack on this receiver. When you play a Super Audio CD, connect the player to the MULTI CHANNEL INPUT or SA-CD/CD IN jacks, or connect a player which can output DSD signals from the HDMI jack to the receiver using an HDMI cable. Refer to the operating instructions supplied with the Super Audio CD player.

If you want to connect several digital equipment, but cannot find an unused input

See “Using other video/audio input jacks” (page 88).

Connections required for listening to content recorded on MDs

It is not necessary to connect all the cords. Connect cords according to the jacks of your equipment.

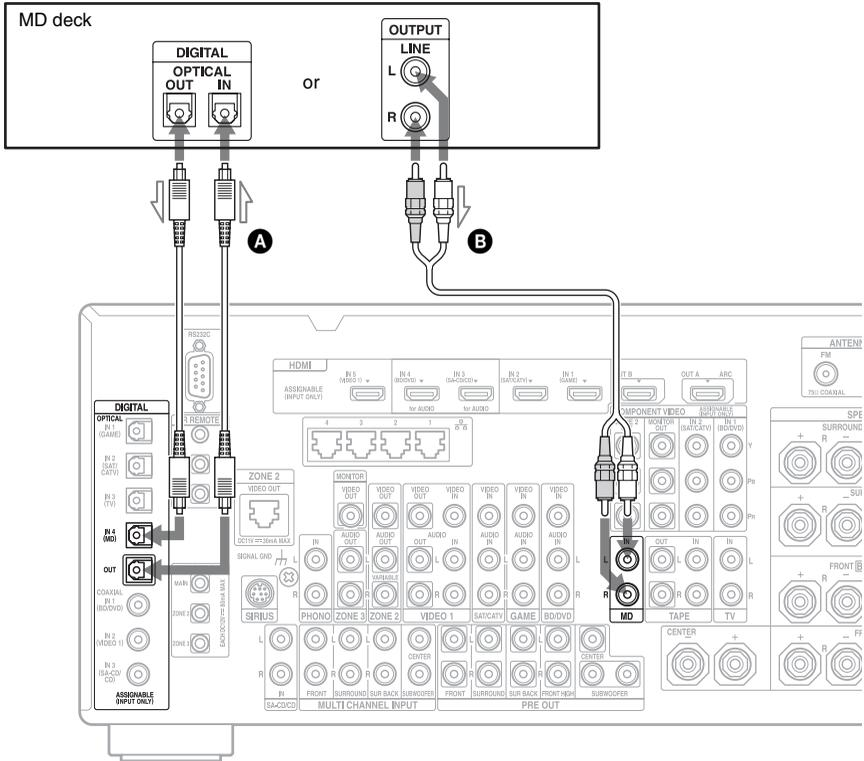

A Optical digital cord (not supplied)

B Audio cord (not supplied)

Notes

- When connecting optical digital cords, insert the plugs straight until they click into place.
- Do not bend or tie optical digital cords.

Tip

All the digital audio jacks are compatible with 32 kHz, 44.1 kHz, 48 kHz, 88.2 kHz and 96 kHz sampling frequencies.

Connections required for listening to the radio

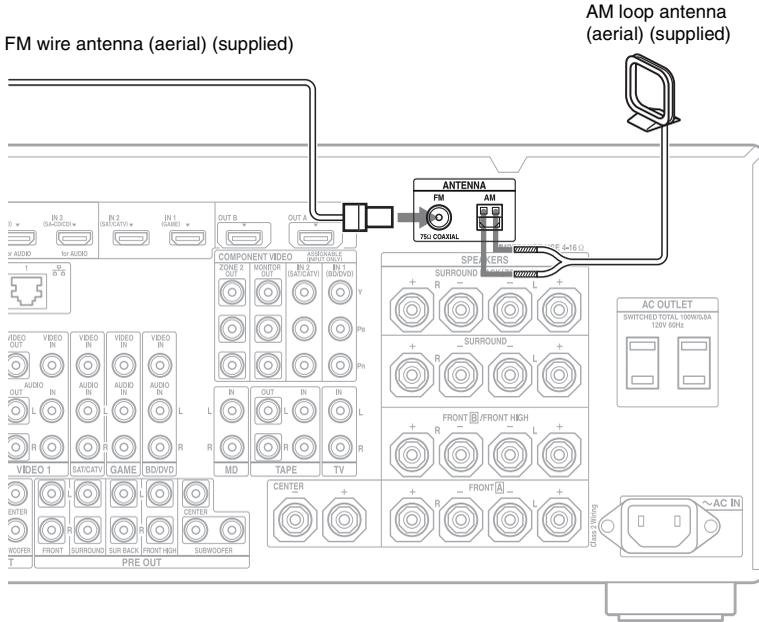

Notes

- To prevent noise pickup, keep the AM loop antenna (aerial) away from the receiver and other equipment.
- Be sure to fully extend the FM wire antenna (aerial).
- After connecting the FM wire antenna (aerial), keep it as horizontal as possible.

Connections required for listening to cassette tapes or records

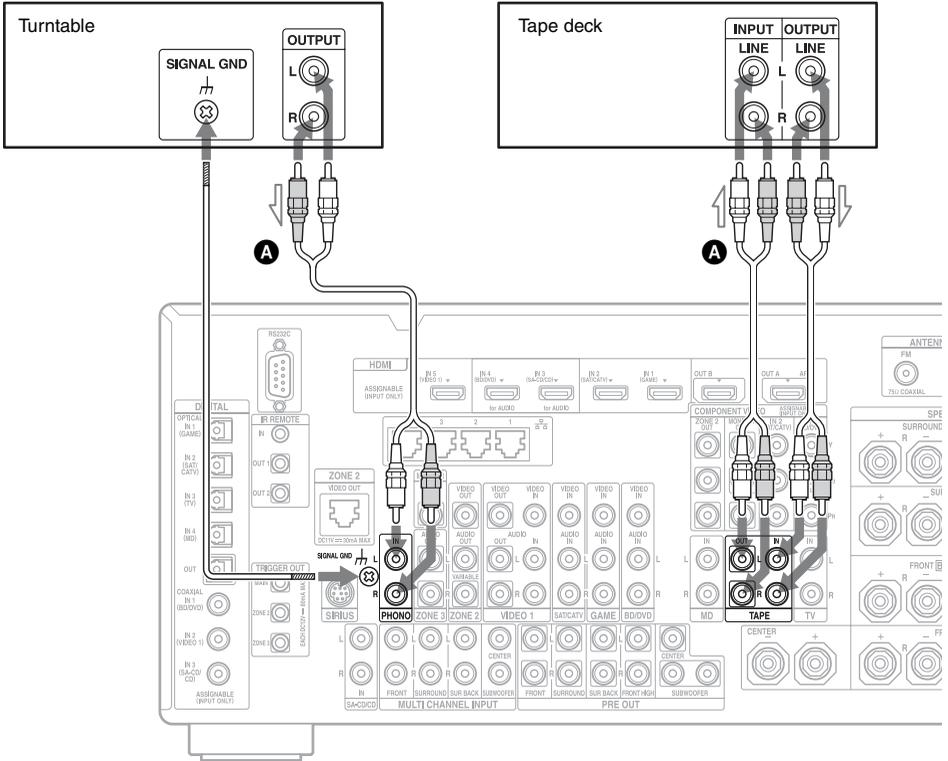

A Audio cord (not supplied)

Note

If your turntable has a ground (earth) wire, connect it to the (⏏) SIGNAL GND terminal.

5: Connecting to the network

If you have an Internet connection, you can connect this receiver to the Internet as well, through the wired LAN connection.

System requirements

The following system environment is required to use the network function of the receiver.

A Broadband line connection

A Broadband line connection to the Internet is required in order to enjoy Internet video or to use the software update function of the receiver.

Modem

This is the device that is connected to the broadband line to communicate with the Internet. Some of these devices are integrated with the router.

Router

- Use a router compatible with 100 Mbps to enjoy content on your home network.
- We recommend that you use a router equipped with the built-in DHCP (Dynamic Host Configuration Protocol) server. This function automatically assigns IP addresses on the LAN.

LAN cable (CAT5)

- We recommend that you use this type of cable for a wired LAN. Some flat-type LAN cables are easily affected by noise. We recommend that you use normal-type cables.
- If the receiver is used in an environment in which there is power supply noise from electric products or in a noisy network environment, use a shielded-type LAN cable.

6: Preparing the receiver and the remote control

Connecting the AC power cord (mains lead)

Connect the supplied AC power cord (mains lead) to the AC IN terminal on the receiver firmly, then connect the AC power cord (mains lead) to a wall outlet.

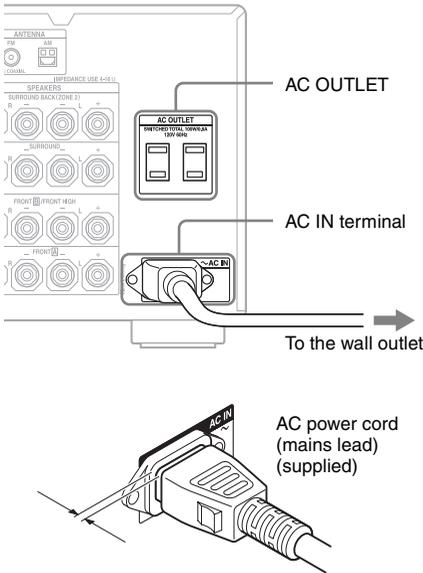

A several space is left between the plug and the rear panel even when the power cord (mains lead) is inserted firmly. The cord is supposed to be connected this way. This is not malfunction.

Notes

- The AC OUTLET(s) on the rear of the receiver is a switched outlet, which supplies power to the connected component only while the receiver is turned on.
- If the power for zone 2 or zone 3 is turned on, the AC OUTLET(s) supplies power to the connected component even when the receiver (main zone) is in standby mode.

- Make sure that the total power consumption of the equipment connected to the receiver's AC OUTLET(s) does not exceed the wattage stated on the rear panel. Do not connect high-wattage electrical home appliances such as electric irons, fans, or TVs to this outlet. This may cause a malfunction.

Turning on the receiver

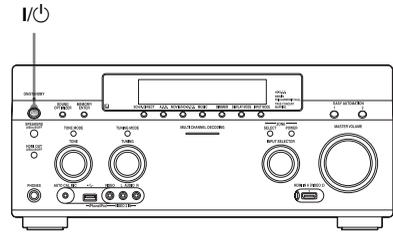

Press I/O to turn on the receiver.

You can also turn on the receiver using I/O on the remote control.

When you turn off the receiver, press I/O again. "STANDBY" flashes on the display window. Do not disconnect the AC power cord (mains lead) while "STANDBY" is flashing. This may cause a malfunction.

To save the power in standby mode

Set "Control for HDMI" (page 113), "Pass Through" (page 113), "Network Standby" (page 115) and "RS232C Control" (page 118) to "Off," and turn off the power for zone 2/ zone 3.

If "Control for HDMI" (page 113), "Pass Through" (page 113), or "Network Standby" (page 115) is set to "On," or the power for zone 2 or zone 3 is turned on, the lamp above I/O lights up in amber.

Note

The top of the receiver may become hot while the receiver is in standby mode. This condition occurs because current is flowing in the internal circuits of the receiver. This is not a malfunction.

Performing initial setup operations (clearing all memorized settings)

Before using the receiver for the first time, initialize the receiver by performing the following procedure. This procedure can also be used to revert back to the factory default settings.

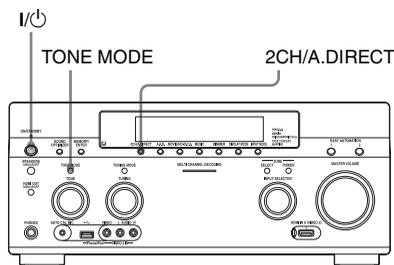

- 1 Press I/⏻ to turn off the receiver.**
- 2 While holding down the TONE MODE and 2CH/A.DIRECT, press I/⏻ to turn on the receiver.**
- 3 Release the TONE MODE and 2CH/A.DIRECT after a few seconds.**

The “MEMORY CLEARING...” appears on the display window for a while, then changes to “MEMORY CLEARED!” Changes or adjustments made to the settings are now reset to the defaults.

Note

It takes about one minute for the memory to be cleared completely. Do not turn the receiver off until “MEMORY CLEARED!” appears on the display.

Inserting batteries into the remote control

Insert two R6 (size-AA) batteries in the RM-AAL040 remote control, and the RM-AAU124 remote control. Observe the correct polarity when installing batteries.

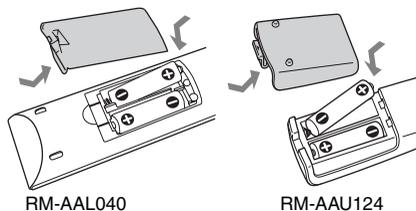

Notes

- Do not leave the remote control in an extremely hot or humid place.
- Do not use a new battery with old ones.
- Do not mix manganese batteries and other kinds of batteries.
- If you do not intend to use the remote control for an extended period of time, remove the batteries to avoid possible damage from battery leakage and corrosion.
- When you replace or remove the batteries, the programmed codes may be cleared. If this happens, program the remote control codes again (page 128, 132, 133).

7: Setting up the receiver using the Easy Setup

You can set the basic settings of the receiver easily by operating the receiver in accordance with the instructions on the TV screen.

Switch the input of the TV to the input to which the receiver is connected.

When you turn on the receiver for the first time, the EULA screen appears on the TV screen*. Agree to the EULA to proceed to the Easy Setup screen, then set up the receiver in accordance with the instructions on the Easy Setup screen.

You can set up the following functions using the Easy Setup.

- Speaker Settings (Auto Calibration)
- Internet Settings

* If the EULA screen does not appear, display the EULA screen from “EULA” in the System Settings menu, then confirm and agree to the EULA.

Notes on Speaker Settings (Auto Calibration)

Insert the plug of the optimizer microphone all the way inside the AUTO CAL MIC jack.

Confirm active subwoofer setup

- When a subwoofer is connected, turn on the subwoofer and turn up the volume prior to activating the subwoofer. Turn the LEVEL knob to just before the mid-point.
- If you connect a subwoofer with the crossover frequency function, set the value to maximum.
- If you connect a subwoofer with an auto standby function, set it to off (deactivated).

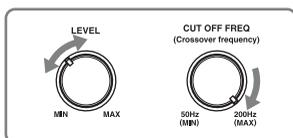

Notes

- Depending on the characteristics of the subwoofer you are using, the setup distance value may be different from the actual position.
- If you perform “Speaker Settings (Auto Calibration)” using the Easy Setup, the measurement results will be overwritten and saved on the currently selected position (“Pos.1” is selected as the factory default setting).

Tip

Depending on the position of the subwoofer, the measurement results for polarity may vary. However, there will be no problems even if you continue to use the receiver with that value.

When you connect two subwoofers to the receiver

If you cannot obtain measurement results of the “Auto Calibration” function correctly, depending on the environment, or you want to make fine adjustments, you can setup the subwoofers manually. For details, see “Speaker Setup” in the Speaker Settings menu (page 104).

Notes on the speaker impedance

- If you are not sure of the impedances of the speakers, refer to the operating instructions supplied with your speakers. (This information is often on the back of the speaker.)
- When you connect all speakers with a nominal impedance of 8 ohms or higher, set “Speaker Impedance” to “8 Ω.” When connecting other types of speakers, set it to “4 Ω.”
- When you connect front speakers to both the FRONT **[A]** and FRONT **[B]/FRONT HIGH** terminals, and you use the FRONT **[B]/FRONT HIGH** terminals for the FRONT **[B]** speakers, connect the speakers with a nominal impedance of 8 ohms or higher.
 - When you connect speakers with impedance of 16 ohms or higher in both “**[A]**” and “**[B]/FRONT HIGH**” configuration:

8: Setting up connected equipment

To output multi-channel digital audio, check the digital audio output setting on the connected equipment.

For a Sony Blu-ray Disc Player, check that “Audio (HDMI),” “DSD Output Mode,” “Dolby Digital,” and “DTS” are set to “Auto,” “On,” “Dolby Digital,” and “DTS,” respectively (as of September 1, 2011).

For a PlayStation 3, check that “BD/DVD Audio Output Format (HDMI)” and “BD Audio Output Format (Optical Digital)” are set to “Bitstream” (with system software version 3.70).

For details, refer to the operating instructions supplied with the connected equipment.

9: Preparing a computer to use as a server

A server is a device which delivers content (music, photos, and videos) to a DLNA device on a home network.

You can play back content stored on a computer on a home network with this receiver via that network after you have installed application software* which has a DLNA compliant server function.

* If you use a Windows 7-based computer, use Windows Media® Player 12 bundled with Windows 7.

Guide to on-screen display operation

You can display the menu of the receiver on the TV screen and select the function you want to use on the TV screen by pressing $\uparrow/\downarrow/\leftarrow/\rightarrow$ and \oplus on the remote control.

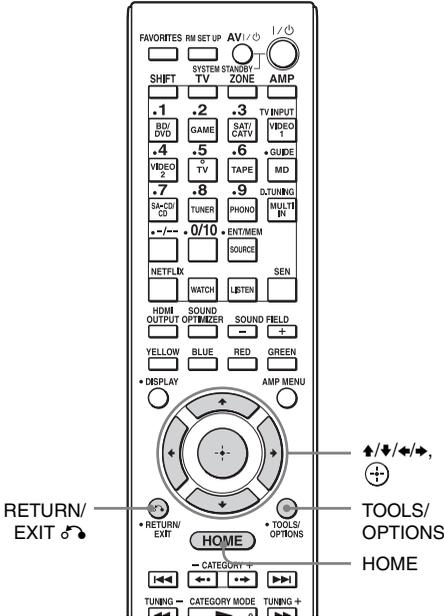

Using the menu

1 Switch the input of the TV to the input to which the receiver is connected.

2 Press **HOME**.

The home menu is displayed on the TV screen.

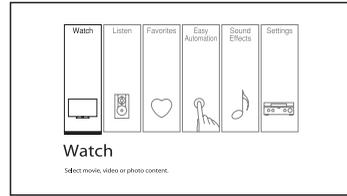

3 Press \leftarrow/\rightarrow repeatedly to select the menu you want, then press \oplus to enter the menu mode.

The menu item list appears on the TV screen.

Example: When you select "Watch."



Tip

When "● Option" appears in the lower right portion of the screen, you can display the option menu by pressing **TOOLS/OPTIONS** and select a related function without reselecting the menu.

To return to the previous screen

Press **RETURN/EXIT**.

To exit the menu

Press **HOME** to display the home menu, then press **HOME** again.

Overview of the main menus

Menu	Description
Watch	Selects the video or photo source to be input to the receiver, or the video or photo content to be delivered via Internet video or a home network (page 54).
Listen	Selects the music source to be input to the receiver, or the music content to be delivered via Internet video or a home network (page 54).
Favorites	Displays the Internet content added to the Favorites List. You can save up to 18 favorite Internet content items (page 58).
Easy Automation	Enables you to save various settings with the receiver and recalling the settings all at one time (page 91).
Sound Effects	Enables you to enjoy sound development provided by various Sony proprietary technologies or functions (page 71).
Settings	You can adjust the settings of the receiver (page 98).

Enjoying images/sound

Enjoying images/sound from the connected equipment

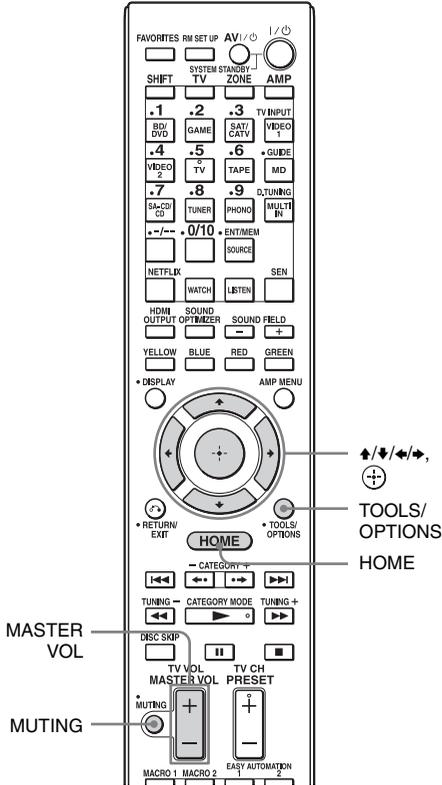

- 1** Select “Watch” or “Listen” from the home menu, then press .

The menu item list appears on the TV screen.

- 2** Select the equipment you want, then press .

- 3** Turn on the equipment and start playback.

- 4** Press MASTER VOL +/- to adjust the volume.

Tips

You can adjust the volume differently using the MASTER VOLUME knob on the receiver or the MASTER VOL +/- button on the remote control.

- To turn the volume up or down quickly
 - Turn the MASTER VOLUME knob quickly.
 - Press and hold the MASTER VOL +/- button.
- To make fine adjustment
 - Turn the MASTER VOLUME knob slowly.
 - Press the MASTER VOL +/- button and release it immediately.

To activate the muting function

Press MUTING on the remote control. To cancel, press MUTING on the remote control again or press MASTER VOL + to raise the volume. If you turn the receiver off while the sound is muted, the muting selection is cancelled.

To avoid damaging your speakers

Before you turn off the receiver, be sure to turn down the volume level.

USB Device/WALKMAN

You can play video/music/photo files on the connected USB device.

For playable types of files, see “Playable types of files” (page 151).

1 Connect the USB device to the (USB) port on the receiver.

Refer to the operating instructions of the USB device before connecting.

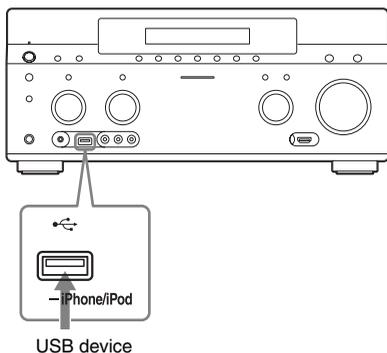

2 Select “Watch” or “Listen” from the home menu, then press .

3 Select “My Video,” “My Music,” or “My Photo,” then press .

Note

If no picture is output, change the setting for “Playback Resolution” (page 111).

4 Select “USB Device,” then press .

The folders and video/music/photo files are listed on the TV screen.

5 Press , , , and to select the file that you want to play.

The image or sound from the USB device is played on the receiver.

Notes

- Do not remove the USB device during operation. To avoid data corruption or damage to the USB device, turn the receiver off when removing the USB device.
- If you connect a WALKMAN to the receiver, operate the WALKMAN using the remote control of the receiver the same way you do when you connect other USB devices to the receiver. You cannot use the controls on the WALKMAN.

iPhone/iPod

You can enjoy the music/video/photo and charge the battery of an iPhone/iPod via the receiver.

For details on the compatible iPhone/iPod models with this function, see page 60.

Note

You cannot use headphones during playback.

1 Connect the iPhone/iPod to the (USB) port on the receiver.

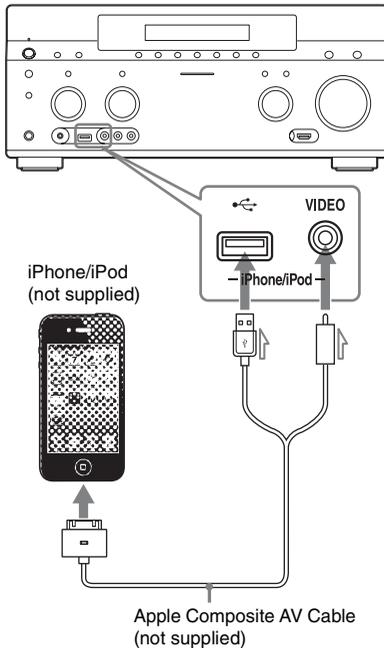

2 Select “Watch” or “Listen” from the home menu, then press .

3 Select “My Video,” “My Music,” or “My Photo,” then press .

Note

If no picture is output, change the setting for “Playback Resolution” (page 111).

4 Select “iPod (front),” then press .

The video/music files are listed on the TV screen.

If you select “iPod (front)” on “My Photo,” select a photo file using the controls on the iPhone/iPod (you do not need to proceed to step 5).

5 Press , , , and to select the file that you want to play.

The image or sound from the iPhone/iPod is played back on the receiver.

You can operate the iPhone/iPod using the buttons on the remote control (page 60).

For operation details of the iPhone/iPod, also refer to the operating instructions of the iPhone/iPod.

DLNA

You can play video/music/photo files on other DLNA-certified devices by connecting them to your home network.

1 Select “Watch” or “Listen” from the home menu, then press **(+)**.

2 Select “My Video,” “My Music,” or “My Photo,” then press **(+)**.

Note

If no picture is output, change the setting for “Playback Resolution” (page 111).

3 Select the DLNA server icon, then press **(+)**.

The folders and video/music/photo files are listed on the TV screen.

4 Press **↑/↓/←/→** and **(+)** to select the file that you want to play.

The image or sound from the DLNA server is played back on the receiver.

Internet video

You can play back a variety of Internet content using the receiver.

1 Connect the receiver to a network (page 45).

2 Select “Watch” or “Listen” from the home menu, then press **(+)**.

3 Select “Internet Video,” “Internet Music” or “Internet Photo,” then press **(+)**.

The Internet content screen appears.

Note

If no picture is output, change the setting for “Playback Resolution” (page 111).

4 Select an Internet content provider icon, then press **(+)**.

If the Internet content list has not been retrieved, it will be represented by an unacquired icon or a new icon.

Note

The Internet content is subject to being suspended or changed without notice.

To use the control panel

The control panel appears when the video file starts playing. The displayed items may differ, depending on Internet content providers.

To display again, press DISPLAY.

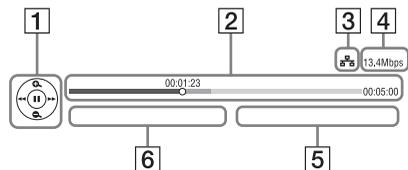

1 Control display
Press **↑/↓/←/→** or **(+)** for playback operations.

- 2 Playing status bar
Status bar, cursor indicating the current position, playing time, duration of the video file
- 3 Network condition indicator
- 4 Network transmission speed
- 5 The next video file name
- 6 The currently selected video file name

Registering your favorite content

You can register your favorite Internet content in “Favorites List.”

- 1 **Display the Internet content screen.**
- 2 **Select an Internet content provider icon you want to register in Favorites List, then press TOOLS/OPTIONS.**
- 3 **Select “Add to Favorites,” then press .**

To remove content from Favorites List

- 1 Press FAVORITES.
The Favorites List appears.
- 2 Select an Internet content provider icon you want to remove from Favorites List, then press TOOLS/OPTIONS.
- 3 Select “Remove from Favorites,” then press .

Available options

Item	Details
Favorites List	Displays the Favorites List.
Add to Favorites	Adds Internet content to the Favorites List.
Remove from Favorites	Removes Internet content from the Favorites List.
IP Content Noise Reduction	Adjusts the picture quality of Internet video content.

FM/AM

You can listen to FM and AM broadcasts through the built-in tuner. Before operation, make sure you have connected the FM and AM antennas (aerials) to the receiver (page 43).

- 1** Select “Listen” from the home menu, then press \odot .
- 2** Select “FM/AM,” then press \odot .

FM/AM screen

You can select and operate each item on the screen by pressing $\uparrow/\downarrow/\leftarrow/\rightarrow$ and \odot .

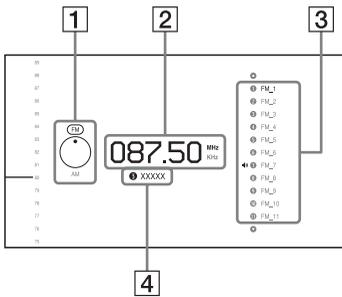

- 1** Band switch (page 62)
- 2** Frequency indication (page 62)
- 3** Preset station list (page 63)
- 4** Preset station name (page 63)

SIRIUS

You can listen to the satellite radio. Before operation, make sure you have connected a satellite radio tuner to the receiver and prepare to listen to the satellite radio (page 65, 65).

- 1** Select “Listen” from the home menu, then press \odot .
- 2** Select “SIRIUS,” then press \odot .

SIRIUS screen

You can select and operate each item on the screen by pressing $\uparrow/\downarrow/\leftarrow/\rightarrow$ and \odot .

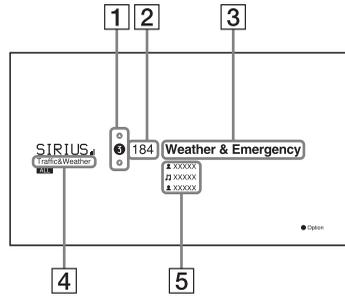

- 1** Preset number (page 67)
- 2** Channel number (page 66)
- 3** Channel name (page 66)
- 4** Category name (page 66)
- 5** Information
Indicates various information, such as artist, song title, etc.

Enjoying an iPhone/iPod

Playing files on an iPhone/iPod

Compatible iPhone/iPod models

The compatible iPhone/iPod models are as follows. Update your iPhone/iPod with the latest software before using with the receiver.

Compatible models are as follows:

- iPod touch
 - iPod touch 4th generation/iPod touch 3rd generation/iPod touch 2nd generation/iPod touch 1st generation
- iPod nano
 - iPod nano 6th generation/iPod nano 5th generation (video camera)/iPod nano 4th generation (video)/iPod nano 3rd generation (video)/iPod nano 2nd generation (aluminum)/iPod nano 1st generation
- iPod
 - iPod 5th generation (video)/iPod classic
- iPhone
 - iPhone 4/iPhone 3GS/iPhone 3G/iPhone

To operate the iPhone/iPod using the remote control

You can operate the iPhone/iPod using the buttons on the remote control. The following table shows an example of buttons that can be used. (Depending on the iPhone/iPod model, the operation may be different.)

For “My Video”/“My Music”

Press	Operation
▶	Starts play.
	Pauses play.
■	Stops play.
◀◀ or ▶▶	Fast reverses or forwards.
◀◀◀ or ▶▶▶	Goes to the previous/next file or chapter (if any).

For “My Photo”

Press	Operation
▶,	Starts/pauses play.
■	Pauses play.
◀◀ or ▶▶	Fast reverses or forwards.
◀◀◀ or ▶▶▶	Goes to the previous/next file.
DISPLAY	Turns the backlight on (or extends it for 30 seconds).
TOOLS/ OPTIONS	Returns to previous display/folder hierarchy on iPhone/iPod.
RETURN/ EXIT ↵, ←	Returns to previous screen of the receiver’s GUI.
↑/↓	Selects the previous/next item.
⊕, →	Enters the selected item.

Notes

- You cannot transfer songs onto the iPhone/iPod from this receiver.
- Sony cannot accept responsibility in the event that data recorded to iPhone/iPod is lost or damaged when using an iPhone/iPod connected to this receiver.
- This product has been designed specifically to work with iPhone/iPod and has been certified to meet Apple performance standards.
- Do not remove the iPhone/iPod during operation. To avoid data corruption or damage to the iPhone/iPod, turn the receiver off when connecting or removing the iPhone/iPod.
- When you connect an iPod that is not compatible with the video output function and select “iPod (front)” in “My Video” or “My Photo,” an alert message appears on the TV screen.

Tips

- The iPhone/iPod is charged when connected to the receiver while the receiver is turned on.
- The receiver can recognize up to 3,000 files (including folders).

Playing files on a home network (DLNA)

This receiver can be used as a player and renderer.

- Server: Stores and sends files.
- Player: Receives and plays files from the server.
- Renderer: Receives and plays files from the server, and can be operated by another device (controller).
- Controller: Operates the renderer component.

Preparations for using the DLNA function

- Connect the receiver to your home network (page 45).
- Prepare other DLNA-certified equipment. For details, refer to the operating instructions of the equipment.

To play remote files by operating the receiver (Renderer) via a DLNA controller

You can operate the receiver with a DLNA-certified controller, such as Windows Media[®] Player 12, when playing files stored on a DLNA server.

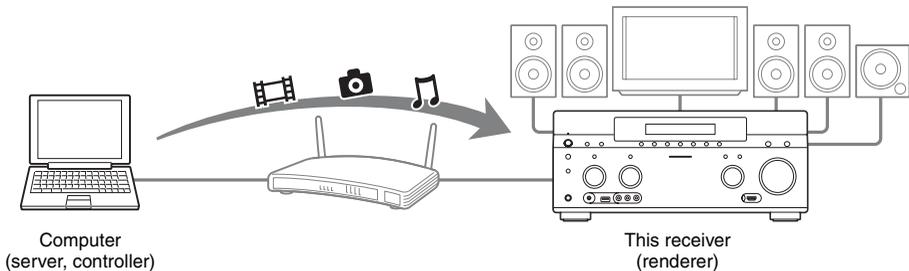

Control this receiver using a DLNA controller. For details of operation, see the operating instructions of the DLNA controller.

Note

Do not operate the receiver with the supplied remote and a DLNA controller at the same time.

Tip

The receiver is compatible with the “Play To” function of Windows Media[®] Player 12 that comes standard with Windows 7.

Tuning

Listening to FM/AM radio

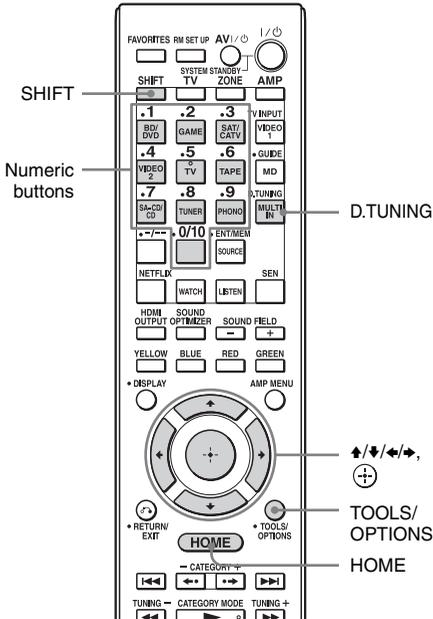

Tuning to a station automatically (Auto Tuning)

- 1 Select the frequency indication on the FM/AM screen.
- 2 Press **↑/↓**.
 - ↑ scans from lower to higher frequency stations and ↓ for scanning higher to lower.
 - The receiver stops scanning whenever a station is received.

In case of poor FM stereo reception

- 1 Tune in the station you want to listen to using Auto Tuning, Direct Tuning (page 62), or select the preset station you want (page 63).
- 2 Press **TOOLS/OPTIONS**. The option menu appears.
- 3 Select “STEREO/MONO,” then press **⊕**.
- 4 Select “MONO,” then press **⊕**.

Toggling between FM and AM radio

- 1 Select “Listen” from the home menu, then press **⊕**.
- 2 Select “FM/AM,” then press **⊕**. The FM/AM screen appears.
- 3 Select the band switch.
- 4 Press **↑/↓** to select “FM” or “AM,” then press **⊕**.

Tuning into a station directly (Direct Tuning)

Enter the frequency of a station directly by using the numeric buttons on the remote control.

- 1 Press **SHIFT**, then press **D.TUNING** on the FM/AM screen.
- 2 Press the numeric buttons to enter the frequency, then press **⊕**.

Example 1: FM 102.50 MHz

Select 1 → 0 → 2 → 5

Example 2: AM 1,350 kHz

Select 1 → 3 → 5 → 0

Tips

- Adjust the direction of the AM loop antenna (aerial) for optimum reception upon tuning to an AM station.
 - The tuning scale for direct tuning is shown below.
 - FM band 100 kHz
 - AM band 10 kHz*
- * The AM tuning scale can be changed (page 64).

If you cannot tune to a station

“----.---MHz” or “----.---kHz” appears and then the display returns to the current frequency.

Make sure you have entered the right frequency. If not, repeat step 2. If you still cannot tune to a station, the frequency may not be in use in your area.

Programming FM/AM radio stations

You can program up to 30 FM and 30 AM stations as your favorite stations as preset stations.

1 Tune to the station that you want to program using Auto Tuning (page 62) or Direct Tuning (page 62).

In case of poor FM stereo reception, switch the FM reception mode (page 62).

2 Press TOOLS/OPTIONS.

The option menu appears.

3 Select “Set Preset,” then press .

4 Select a preset number, then press .

The station is stored as the selected preset number.

5 Repeat steps 1 to 4 to program another station.

You can store stations as follows:

- FM band: FM1 to FM30
- AM band: AM1 to AM30

Tuning to preset stations

1 Select “Listen” from the home menu, then press .

2 Select “FM/AM,” then press .

3 Select the preset number from the list, then press .

Preset numbers from 1 to 30 are available.

To name preset stations (Name Input)

1 Select the preset number on which you want to name.

2 Press TOOLS/OPTIONS.

The option menu appears.

3 Select “Name Input,” then press .

The soft keyboard appears on the screen.

4 Press , , , and to select a character one by one to enter the name.

5 Select “Enter,” then press .

The name you entered is registered.

To cancel naming input

Press RETURN/EXIT  or HOME.

Changing the AM tuning scale

You can change the AM tuning scale to either 9 kHz or 10 kHz on the receiver.

All preset stations will be erased when you change the tuning scale.

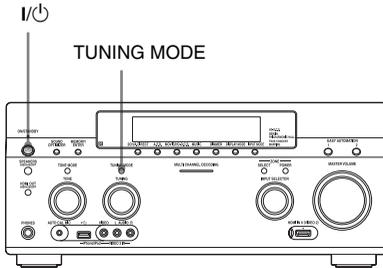

- 1 Press I/O to turn off the receiver.**
- 2 While holding down TUNING MODE, press I/O on the receiver.**
- 3 Change the current AM tuning scale to 9 kHz (or 10 kHz).**

To reset the scale to 10 kHz (or 9 kHz), repeat the procedure above.

Available options

Item	Details
STEREO/MONO	Switches the FM reception mode to stereo or mono.
Set Preset	Stores a radio station on a specific preset number.
Name Input	Names a preset station.

Listening to the satellite radio

To listen to satellite radio on your Sirius-Ready® receiver, you'll need to add a Sirius satellite radio tuner (sold separately). Sirius satellite radio service is available to residents of the United States (except Alaska and Hawaii), Puerto Rico (with coverage limitations) and Canada.

Only SiriusXM brings you more of what you love, all in one place. Get over 130 channels, including an incredible variety of commercial-free music channels from Pop, Rock, Country, R&B, Hip-Hop and Jazz to Classical and much more. You also get the best professional and college sports, including play-by-play and expert sports talk and analysis, plus exclusive entertainment, talk, comedy, family programming and news from your most trusted sources.

After you purchase a Sirius tuner, you'll need to activate and subscribe to the service to listen to satellite radio. Easy-to-follow installation and set-up instructions are provided with the satellite tuners.

Packages for Sirius Tuners

Sirius Select

Over 130 channels including a selection of premium programming like 2 channels of Howard Stern, every NFL game, every NASCAR® race, Martha Stewart and more.

Sirius Premier

Over 140 channels including everything the Select package offers, plus additional premium programming like Oprah Radio®, MLB Network Radio™, NHL® and NBA games, Opie & Anthony and more.

Family friendly packages are also available to restrict channels that feature mature programming.

To subscribe to a Sirius package, U.S. customers (including Puerto Rico) should visit www.siriusxm.com or call 1-888-539-7474. Canadian customers should visit www.sirius.ca. All programming packages may not be available in Canada.

Connecting a satellite radio tuner

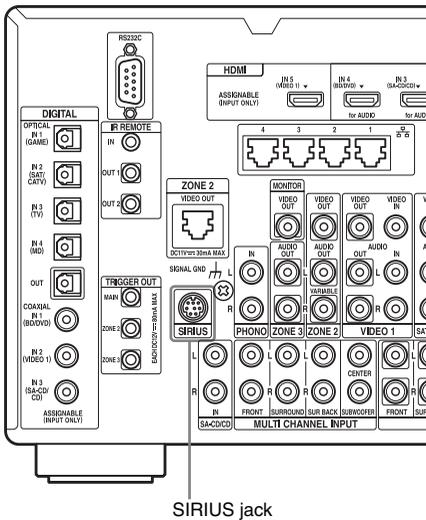

Connect the SiriusConnect Home tuner. When you use the SiriusConnect Home tuner with this receiver, be sure to connect the AC power adaptor supplied with the tuner to a wall outlet. Keep the SiriusConnect Home tuner, antenna, and AC power adaptor away from the speaker cords and the power cord to avoid picking up noise.

Preparing to listen to the satellite radio

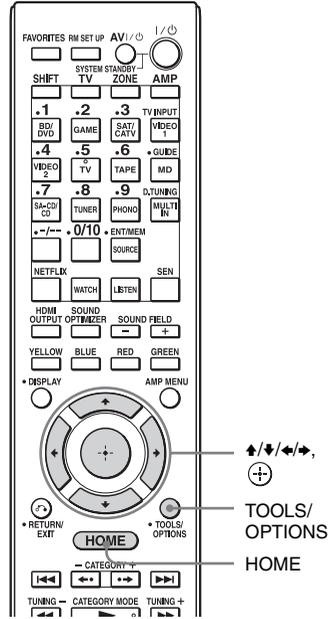

Tuning

Checking the ID number

- 1 Select "Listen" from the home menu, then press \odot .
- 2 Select "SIRIUS," then press \odot .
- 3 Select "All Categories," then press \odot .
- 4 Select the channel 0, then press \odot .
- 5 Check the Sirius ID on the TV screen and write it in the space provided here.

Sirius ID: _____

You can also check the Sirius ID using the display on the receiver.

Checking receiving conditions (Antenna Aiming)

- 1 Select “Listen” from the home menu, then press \oplus .
- 2 Select “SIRIUS,” then press \oplus .
- 3 Press TOOLS/OPTIONS.
The option menu appears.
- 4 Select “Antenna Aiming,” then press \oplus .
The Antenna Aiming screen appears.
- 5 While checking the quality of the reception, adjust the direction of the antenna to obtain the best reception.

To exit the menu

Press RETURN/EXIT \leftarrow or HOME.

Selecting a channel of the satellite radio

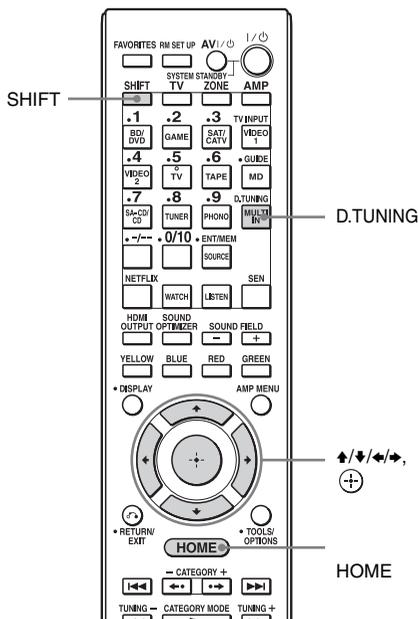

Selecting a channel by category (Category Mode)

You can select a channel from one category or all the categories.

- 1 Select “Listen” from the home menu, then press \oplus .
- 2 Select “SIRIUS,” then press \oplus .
- 3 Select the category, then press \oplus .
 - All Categories: You can select a channel from all the categories.
 - (category name): You can select a channel from one category.

4 Select the channel, then press



The selected channel is being received.
The channel information is displayed on the TV screen.

Selecting a channel by inputting the channel number directly (Direct Tuning)

Enter the channel number directly by using the numeric buttons on the remote control. This operation cannot be performed using the simple remote control.

- 1 Select “Listen” from the home menu, then press .
- 2 Select “SIRIUS,” then press .
- 3 Press SHIFT, then press D.TUNING.
- 4 Press the numeric buttons to enter the channel number, then press .

The selected channel is tune in.

Presetting satellite radio channels

You can select the channels you want directly by presetting them using the preset numbers. You can preset up to 30 Sirius satellite radio channels.

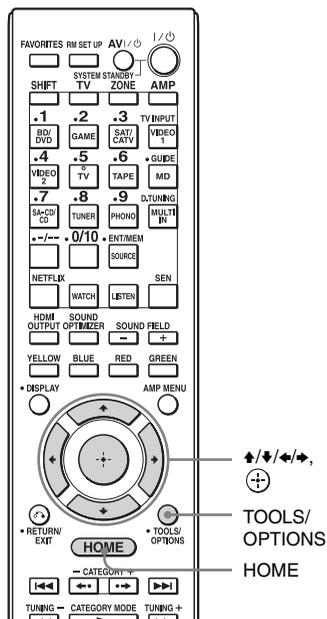

Tuning

- 1 Select a channel you want to preset using Category Mode (page 66) or Direct Tuning (page 67).
 - 2 Press TOOLS/OPTIONS.
The option menu appears.
 - 3 Select “Set Preset,” then press .
 - 4 Select the preset number you want to use as the preset channel, then press .
- Preset channels from 1 to 30 are available, and a default channel is preset for all the preset channels when you purchase the receiver.
The selected channel is registered as the preset channel you selected in step 1.

continued

5 Repeat steps 1 to 4 to preset another channel.

You can store channels from 1 to 30.

Selecting preset channels

- 1 Select “Listen” from the home menu, then press \odot .
- 2 Select “SIRIUS,” then press \odot .
- 3 Select “Presets,” then press \odot .
- 4 Select the preset number from the preset list, then press \odot .
You can select stored preset channels from 1 to 30.

Note

The channel information you have preset may be changed if Sirius XM Radio Inc. change its channel programming.

Restricting access to specific channels (Parental Lock)

You can restrict access to certain channels using your own lock code. When you select a channel using Category Mode, locked channels are skipped. The lock code is set to “0000” as the default.

Change the lock code before you use this function for the first time. See “To change the lock code (Lock Code)” (page 69).

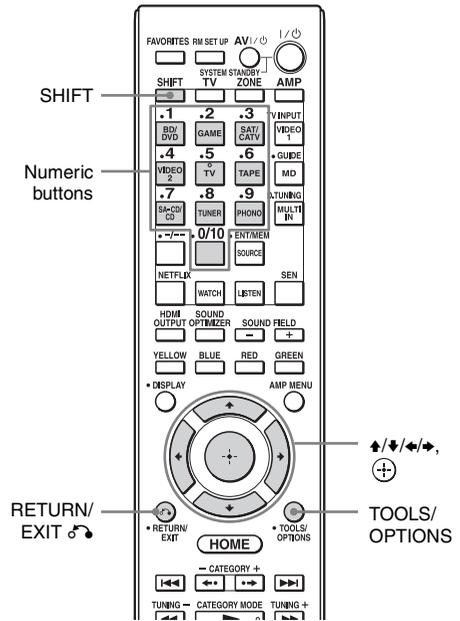

- 1 Select a channel you want to lock using Category Mode (page 66) or Direct Tuning (page 67).
- 2 Press TOOLS/OPTIONS.
The option menu appears.
- 3 Select “Parental Lock,” then press \odot .
- 4 Select “ON,” then press \odot .
“Enter your 4-digit lock code.” and the soft numerical keyboard appear.
- 5 Press $\uparrow/\downarrow/\leftarrow/\rightarrow$ and \odot to select your 4-digit lock code.
- 6 Select “ENTER,” then press \odot to enter the lock code.
“The channel has been locked.” appears and the Parental Lock is set.

To delete the numbers you have entered, go back to step 2 by pressing RETURN/EXIT , and then repeat the procedure above from step 2.

To change the lock code (Lock Code)

- 1 Select "Listen" from the home menu, then press .
- 2 Select "SIRIUS," then press .
- 3 Press TOOLS/OPTIONS.
- 4 Select "Lock Code," then press .
"Enter your 4-digit lock code." and the soft numerical keyboard appear.
- 5 Press  and  to select your 4-digit lock code.
- 6 Select "ENTER," then press  to enter the lock code.
"Enter a new lock code." and the soft numerical keyboard appear.
- 7 Repeat steps 5 and 6 to enter a new 4-digit lock code.
"To confirm, enter your new lock code again." appears.
- 8 Repeat steps 5 and 6 to reenter the new lock code.
"The lock code has been changed." appears and the lock code is changed.

To listen to the locked channels

- 1 Select a locked channel you want to listen to using Direct Tuning (page 67).
"Enter your 4-digit lock code." appears.
- 2 Press SHIFT, then enter your 4-digit lock code using the numeric buttons.
The channel is tuned in.

To cancel the Parental Lock

- 1 Select a channel you want to unlock using Direct Tuning (page 67).

- 2 Press TOOLS/OPTIONS.
The option menu appears.
- 3 Select "Parental Lock," then press .
- 4 Select "OFF," then press .
"Enter your 4-digit lock code." and the soft numerical keyboard appear.
- 5 Press  and  to select your 4-digit lock code.
- 6 Select "ENTER," then press  to enter the lock code.
"The channel has been unlocked." appears and the channel is unlocked.

Notes

- You cannot set individual lock codes for each channel.
- When the receiver is reset to the factory settings, the lock code returns to the default (0000), but the Parental Lock settings are not removed.
- You cannot preset locked channels. If you set the Parental Lock for a preset channel, the preset information for that channel returns to the default.
- You cannot set the Parental Lock for channel 0 or channel 184.

Message list

Message appears	Explanation	Remedies
Antenna Error	The antenna is not connected properly.	Check the connection between the SiriusConnect Home tuner and the antenna.
Acquiring Signal	The receiving condition is not good.	Try moving the antenna to another location. For details about the antenna location, refer to the instructions supplied with the SiriusConnect Home tuner.
Call 888-539-SIRI	You have not subscribed for the selected channel.	—
Check Sirius Tuner	The SiriusConnect Home tuner is not connected properly.	Check all the connections, and then turn the system on again. Also make sure if the AC adaptor supplied with the SiriusConnect Home tuner is connected to a wall socket.
Invalid Channel	You have entered an invalid channel number.	The channel to be tuned in is void due to the change by the broadcast service, or the receiving condition is not good.
Locked Channel	The selected channel is locked.	—
Subscription Updated	The subscription information has been updated.	—
Updating Channels ■■% Completed (■■ are for integers)	Channel information is being updated.	—
Firmware Updating	The SiriusConnect Home tuner software is being updated.	—
Loading	The display for the Sirius satellite radio feature is being prepared.	—
-----	There is no text information in the channel.	This is not an error. The text information may not be displayed, depending on the system condition, for example, right after the system has received a channel.

Selecting the sound field

- 1 Select “Sound Effects,” from the home menu, then press .
- 2 Select “Sound Field,” then press .
- 3 Select the sound field you want.

Playing back with 2-channel sound

You can switch the output sound to 2-channel sound regardless of the recording formats of the software you are using, the playback equipment connected, or the sound field settings of the receiver.

2CH mode	Effect
2ch Stereo	The receiver outputs the sound from the front left/right speakers only. There is no sound from the subwoofer. Standard 2 channel stereo sources completely bypass the sound field processing and multi-channel surround formats are downmixed to 2 channels.
2ch Analog Direct	You can switch the audio of the selected input to 2 channel analog input. This function enables you to enjoy high quality analog sources. When using this function, only the volume and front speaker level can be adjusted.

To listen to music through headphones connected to the receiver

Sound field	Effect
Headphone (2ch)	This mode is selected automatically if you use headphones and when the mode other than “2ch Analog Direct” is selected. Standard 2 channel stereo sources completely bypass the sound field processing and multi-channel surround formats are downmixed to 2 channels.
Headphone (Direct)	Outputs the analog signals without processing by the tone, sound field, etc.
Headphone (Multi)	This mode is selected automatically if you use headphones when “MULTI IN” is selected. Outputs the front analog signals from the MULTI CHANNEL INPUT jacks.

Playing back with multi-channel surround

The Auto Format Direct (A.F.D.) mode allows you to listen to higher fidelity sound and select the decoding mode for listening to a 2 channel stereo sound as multi-channel sound.

A.F.D. mode	Effect
A.F.D. Auto	Presets the sound as it was recorded/encoded without adding any surround effects.
Multi Stereo	Outputs 2 channel left/right signals from all speakers.

Tip

We usually recommend “A.F.D. Auto.”

Enjoying a surround effect for movies

You can take advantage of surround sound simply by selecting one of the receiver’s preprogrammed sound fields. They bring the exciting and powerful sound of movie theaters into your home.

Sound field	Effect
HD-D.C.S.	HD Digital Cinema Sound (HD-D.C.S.) is Sony’s new innovative home theater technology using the latest acoustic and digital signal processing technologies. It is based on precise response measurement data of a mastering studio. With HD-D.C.S., you are able to enjoy Blu-ray and DVD movies at home with not only the high quality of sound, but also the best sound ambience, just as the movie’s sound engineer intended in the mastering process. You can select the effect type for HD-D.C.S. For details, see “About the effect type for HD-D.C.S.” (page 73).
PLII Movie	Performs Dolby Pro Logic II Movie mode decoding. This setting is ideal for movies encoded in Dolby Surround. In addition, this mode can reproduce sound in 5.1 channel for watching videos of overdubbed or old movies.
PLIIx Movie	Performs Dolby Pro Logic IIx Movie mode decoding. This setting expands Dolby Pro Logic II Movie or Dolby Digital 5.1 to discrete 7.1 movie channels.
PLIIz Height	Performs Dolby Pro Logic IIz mode decoding. This setting can expand a source sound into up to 9.1 channels to which a vertical component is applied, and gives a dimension of presence and depth. “PLIIz Height” is the same sound field as that is described on page 74. You can adjust the gain level for “PLIIz Height.” For details, see “About the gain level for PLIIz Height” (page 75).
Neo:X Cinema	Performs DTS Neo:X Cinema mode decoding. A source recorded in 2 to 7.1 channel format is enhanced up to 9.1 channels.

About the effect type for HD-D.C.S.

HD-D.C.S. has three different types:

Dynamic, Theater, and Studio. Each type has different reflection and reverberation sound mixture levels and is optimized to match a listener's room uniqueness, taste and mood.

■ Dynamic

The “Dynamic” setting is suitable for an environment which is reverberant but lacks a spacious feeling (where sound absorption is not sufficient). This setting emphasizes the reflection of sound and reproduces the sound of a large, classical movie theater. Thus, the spacious feeling of a dubbing theater is emphasized and a unique acoustic field is created.

■ Theater

Factory default setting. The “Theater” setting is suitable for a general living room. This setting reproduces the reverberation of sound just like in a movie theater (dubbing theater). It is most appropriate for watching content recorded on a Blu-ray Disc when you want the atmosphere of a movie theater.

■ Studio

The “Studio” setting is suitable for a living room with the appropriate sound equipment. This setting reproduces the reverberation of sound provided when a theatrical sound source is remixed for a Blu-ray Disc to a volume level suitable for home use. The level of reflection and reverberation of sound is kept to the minimum. However, dialogues and surround effects are reproduced vividly.

Enjoying a surround effect for music

You can take advantage of surround sound simply by selecting one of the receiver's pre-programmed sound fields. They bring the exciting and powerful sound of concert halls into your home.

Sound field	Effect
Berlin Philharmonic Hall	Reproduces the sound characteristics of the Berlin Philharmonic Hall. Also works automatically in conjunction with reception of the "The Berliner Philharmoniker's Digital Concert Hall" Internet service.
True Concert Mapping A	Reproduces the sound characteristics of a concert hall in Amsterdam, Netherlands, which features a large sound stage produced by reflectivity. You can also adjust the effect level. For details, see "About the effect level for True Concert Mapping A/B" (page 75).
True Concert Mapping B	Reproduces the sound characteristics of a concert hall in Vienna, Austria, which features resonant and unique reverberative sound. You can also adjust the effect level. For details, see "About the effect level for True Concert Mapping A/B" (page 75).
Jazz Club	Reproduces the acoustics of a jazz club.
Live Concert	Reproduces the acoustics of a 300-seat live house.
Stadium	Reproduces the feeling of a large open-air stadium.
Sports	Reproduces the feeling of sports broadcasting.
Vocal Height	Raises the sound image using the front high speakers. This setting is appropriate to watching music content on a large screen.
Portable Audio	Reproduces a clear enhanced sound image from your portable audio device. This mode is ideal for MP3 and other compressed music.
PLII Music	Perform Dolby Pro Logic II Music mode decoding. This setting is ideal for normal stereo sources such as CDs.
PLIIx Music	Performs Dolby Pro Logic IIx Music mode decoding. This setting is ideal for normal stereo sources such as CDs.
PLIIz Height	Performs Dolby Pro Logic IIz mode decoding. This setting can expand a source sound into up to 9.1 channels to which a vertical component is applied, and gives a dimension of presence and depth. "PLIIz Height" is the same sound field as that is described on page 72. You can adjust the gain level for "PLIIz Height." For details, see "About the gain level for PLIIz Height" (page 75).
Neo:X Music	Performs DTS Neo:X Music mode decoding. A source recorded in 2 to 7.1 channel format is enhanced up to 9.1 channels.
Neo:X Game	Performs DTS Neo:X Game mode decoding. A source recorded in 2 to 7.1 channel format is enhanced up to 9.1 channels.

About the effect level for True Concert Mapping A/B

You can set the reverberation level for the “True Concert Mapping A/B” sound field. This function is available when the speaker pattern is set so that there are front high speakers, and “Sound Field Mode” is set to “Front High.”

■ Low

Turns down the reverberation volume level.

■ Mid

Sets the reverberation volume level to the factory default.

■ High

Turns up the reverberation volume level.

About the gain level for PLIIz Height

You can adjust the gain level of the front height channels for Pro Logic IIz mode (common for movie and music).

■ Low

No gain will be applied.

■ Mid

+3 dB will be applied (factory default setting).

■ High

+5 dB will be applied.

Sound Field Mode

Lets you set whether or not to output sound from the front high speakers.

This function is available when one of the following sound fields is selected, and the speaker pattern is set so that there are front high speakers.

- HD-D.C.S.
- Berlin Philharmonic Hall
- True Concert Mapping A/B
- Jazz Club
- Live Concert

- Stadium
- Sports
- Neo:X Cinema/Music/Game

■ Front High

Outputs sound from the speakers, including the front high speakers (factory default setting).

If you connect the surround back speakers and the front high speakers to the SURROUND BACK (ZONE 2) terminals and the FRONT **[B]**/FRONT HIGH terminals, respectively, sound is not output from the surround back speakers.

■ Standard

Outputs sound from the speakers, except the front high speakers.

Note

Depending on the setting or the audio format, sound may not be output from the front high speakers even if you set “Sound Field Mode” to “Front High.”

Notes on the sound fields

- The sound fields do not work when “MULTI IN” is selected.
- You cannot select “2ch Analog Direct” when you play back content via a USB device, a home network, or Internet video.
- “Multi Stereo” does not work when multi-channel audio signals are being received.
- The sound fields for movie and music may not work, depending on the input or the speaker pattern you select, or with audio formats.
- The receiver may play back signals at a lower sampling frequency than the actual sampling frequency of the input signals, depending on the audio format.
- “PLIIx Movie/Music,” “PLIIz Height,” and “Vocal Height” do not appear, depending on the speaker pattern you select.
- Some speakers or the subwoofer may not output sound, depending on the sound field setting.

- If there is any noise present, the noise may be different, depending on the sound field you select.
- “Neo:X (Cinema/Music/Game)” does not work when signals with a sampling frequency of 32 kHz are being received.

Using the Sound Optimizer function

The Sound Optimizer function imparts a sense of presence and intensity of sound to playback of high volume sound, regardless of the volume level of the receiver.

You can enjoy clear and dynamic sound even at a low volume, for examples, at night.

The optimum effect to suit your environment is obtained by taking advantage of the “Auto Calibration” function.

- 1** Select “Settings” from the home menu, then press .
- 2** Select “Audio Settings,” then press .
- 3** Select “Sound Optimizer,” then press .
- 4** Select “On,” then press .

The Sound Optimizer function is activated.

You can also set the Sound Optimizer function “On” and “Off” using SOUND OPTIMIZER on the remote control and the receiver.

Notes

- This function does not work in the following cases.
 - “MULTI IN” is selected.
 - “2ch Analog Direct” is being used.
 - Headphones are being used.
- The receiver may play back signals at a lower sampling frequency than the actual sampling frequency of the input signals, depending on the audio format.

Adjusting the equalizer

You can use following parameters to adjust the tonal quality (bass/treble level) of front, center, surround/surround back and front high speakers.

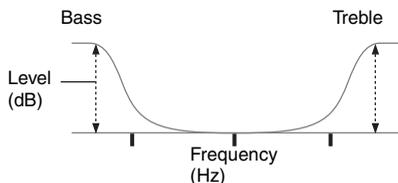

- 1** Select “Settings” from the home menu, then press \oplus .
- 2** Select “Audio Settings,” then press \oplus .
- 3** Select “Equalizer,” then press \oplus .
- 4** Select “Front,” “Center,” “Sur/SB,” or “Front High,” then press \oplus .
- 5** Select “Bass” or “Treble.”
- 6** Adjust the gain, then press \oplus .

Note

- This function does not work in the following cases.
 - “MULTI IN” is selected.
 - “2ch Analog Direct” is being used.

Using the Advanced Auto Volume function

You can adjust the volume appropriate to each type of content automatically.

This function is useful, for example, when the sound of a commercial is louder than the TV programs.

- 1** Select “Settings” from the home menu, then press \oplus .
- 2** Select “Audio Settings,” then press \oplus .
- 3** Select “Advanced Auto Volume,” then press \oplus .
- 4** Select “On,” then press \oplus .

Notes

- Be sure to reduce the volume level before you turn off this function.
- This function does not work in the following cases.
 - “MULTI IN” is selected.
 - “2ch Analog Direct” is being used.
- The receiver may play back signals at a lower sampling frequency than the actual sampling frequency of the input signals, depending on the audio format.

② Outputs sound from speakers in zone 2 using the receiver and another amplifier.

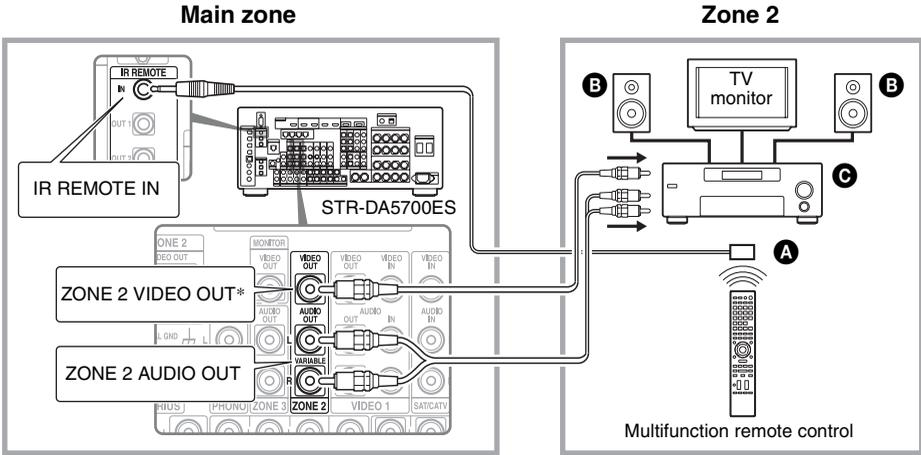

- A** IR repeater (not supplied)
- B** Speakers
- C** Sony Amplifier/Receiver

* You can also connect to the ZONE 2 COMPONENT VIDEO OUT jack.

2:Zone 3 connections

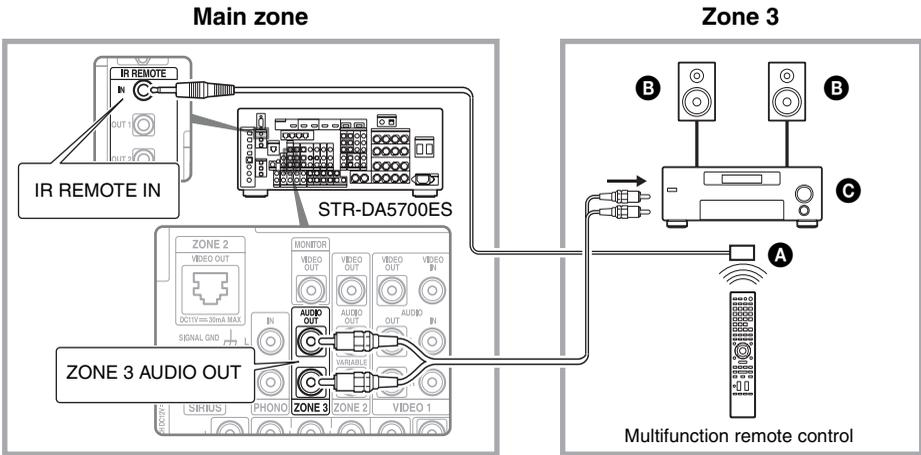

- A** IR repeater (not supplied)
- B** Speakers
- C** Sony Amplifier/Receiver

Making a zone 2 configuration using ZONE 2 VIDEO OUT (RJ-45 jack)

ZONE 2 VIDEO OUT (RJ-45 jack) is used only for custom installation by a qualified person. ZONE 2 VIDEO OUT (RJ-45 jack) is a jack that sends a source video signal to the component video input for zone 2. For details, consult your dealer.

Attention

Do not use this jack for an Ethernet LAN connection. Doing so may cause a malfunction.

ZONE 2 VIDEO OUT (RJ-45 jack) connection

The RJ-45 pinouts use the T568B standard. Refer to the illustration below.

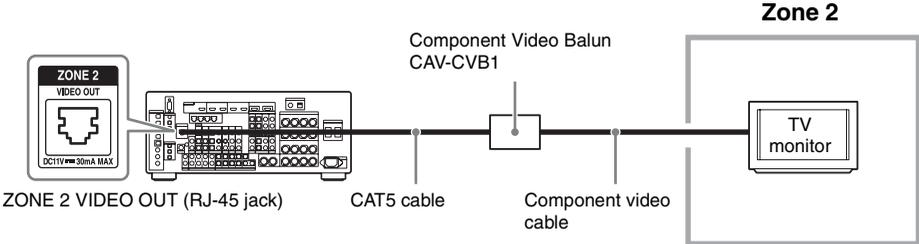

Note

CAV-CVB1 (Component Video Balun) must be used. Other types will cause trouble and may void your warranty.

CAT5 cable

Be sure to verify the CAT5 wiring connection is correct. Use Category 5e or Category 6 cable.

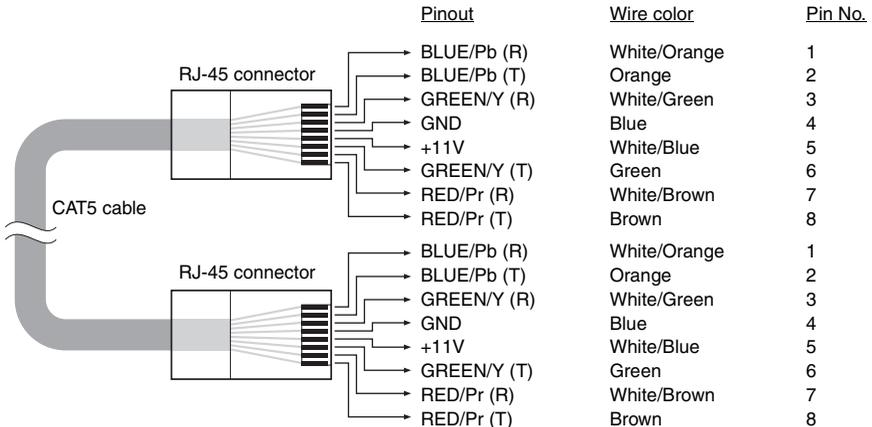

Setting the speakers in zone 2

When the speakers in zone 2 are connected to the SURROUND BACK (ZONE 2) terminals of the receiver (page 78), make the setting so that the sound selected in zone 2 is output from the speakers connected to the SURROUND BACK (ZONE 2) terminals.

For details, see “Speaker Connection” in the Speaker Settings menu (page 104).

Set the volume control for zone 2

You can set the volume control for the ZONE 2 AUDIO OUT jacks variable or fixed.

- 1 Select “Settings” from the home menu, then press **+**.
- 2 Select “Zone Settings,” then press **-**.
- 3 Select “Zone Setup,” then press **+**.
- 4 Select “Line Out” for “Zone2,” then press **+**.
- 5 Select the parameter you want, then press **+**.

Parameter	Explanation
Variable	The volume control is set to -40 dB initially. When you select this parameter, the volume for the ZONE 2 AUDIO OUT and the SURROUND BACK (ZONE 2) terminals can be changed in conjunction with each other. Recommended when using a power amplifier.

Parameter	Explanation
Fixed	The volume control is fixed to ± 0 dB. Recommended when using an equipment with the variable volume control.

Switching the zone setting of the remote control

The remote control is initially set to be used in zone 2. If you want to use it in zone 3, switch the zone setting of the remote control.

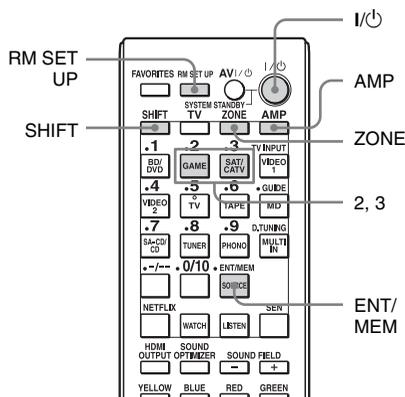

- 1 Press **I/⏻** while pressing **RM SET UP**.
The AMP and ZONE buttons flash.
- 2 Press **ZONE**.
The AMP button goes off, the ZONE button keeps flashing and the SHIFT button lights up.
- 3 Press the numeric button **2** for the zone 2, or **3** for the zone 3 while the ZONE button is flashing.
The ZONE button lights up.

4 Press ENT/MEM.

The ZONE button flashes twice and the remote control switches to zone 2 or zone 3 mode.

Operating the receiver from another zone (ZONE 2/ZONE 3 operations)

The following operations are described for connecting an IR repeater and operating the receiver in zone 2 or zone 3. When an IR repeater is not connected, use this receiver in the main zone.

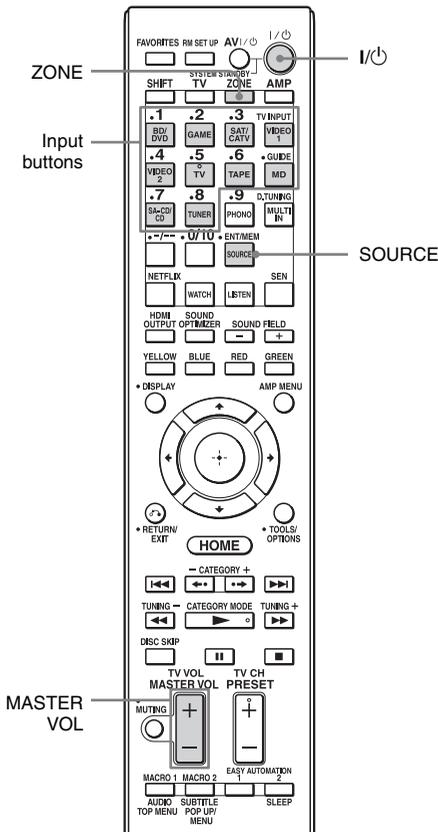

1 Turn on the amplifier in zone 2 or zone 3.

In the case of illustration 1-① (page 78), skip this step.

2 Press ZONE.

The remote control switches to zone 2 or zone 3. Change the zone setting of the remote control to zone 2 or zone 3 in advance (page 81).

3 Press I/⏻.

The zone function is activated.

4 Press one of the input buttons on the remote control to select the source signals you want to output.

For zone 2, analog video and audio signals are output. For zone 3, only analog audio signals are output. When you select SOURCE, the signals of the current input in main zone are output.

5 Adjust to a suitable volume.

- In the case of illustration 1-① (page 78), adjust the volume using MASTER VOL +/- on the remote control.
- In the case of illustration 1-② (page 79) or 2 (page 79), adjust the volume using the receiver in zone 2 or zone 3. If you set “Line Out” for “Zone2” to “Variable,” you can also adjust the volume in zone 2 using MASTER VOL +/- on the remote control (page 81).

To finish the zone 2/zone 3 operation

Press ZONE, then press I/⏻.

Notes

- When SOURCE is selected, the signals input to the MULTI CHANNEL INPUT jacks is not output from the ZONE 2 OUT or ZONE 3 OUT jacks even when “MULTI IN” is selected.
- “TV,” “PHONO,” or “MULTI IN” can be selected in the main zone only.

- Content via a USB device, iPhone/iPod, a home network, or Internet video is available in zone 2 and zone 3 only when SOURCE is selected.
- You can select either “FM” or “AM” from the main zone, zone 2, or zone 3. Priority is given to the choice which has most recently been selected, even if a different choice has already been selected in one of the zones.
- You can select only the same channel from “SIRIUS” when listening in both the main zone, zone 2, and zone 3 simultaneously. Priority is given to the channel which has most recently been selected, even if a different channel has already been selected in one of the zones.

Using Other Features

Using “BRAVIA” Sync features

What is “BRAVIA” Sync?

“BRAVIA” Sync is the name of a function on Sony products that enables compatible equipment connected via HDMI cables to be operated mutually using the “BRAVIA” remote control.

This mutual operation is enabled by the Control for HDMI function using HDMI CEC (Consumer Electronics Control) standardized for HDMI (High-Definition Multimedia Interface).

By connecting Sony equipment that are compatible with the “BRAVIA” Sync with an HDMI cable (not supplied), operation is simplified as below:

- System Power-Off (page 85)
- One-Touch Play (page 85)
- System Audio Control (page 85)
- Audio Return Channel (ARC) (page 86)
- Scene Select (page 86)
- Home Theater Control (page 86)

The Control for HDMI function does not work in the following cases:

- When you connect the receiver to an equipment which is not correspond with Sony Control for HDMI function.
- When you connect the receiver and equipment using other than HDMI connection.
- The Control for HDMI function does not work on an equipment connected to the HDMI OUT B jack of the receiver.

We recommend that you connect the receiver to products featuring “BRAVIA” Sync.

Notes

- The following features may operate with non-Sony equipment. However, compatibility with all non-Sony equipment is not guaranteed.
 - System Power-Off
 - One-Touch Play
 - System Audio Control
- The following features are Sony proprietary functions. They can not operate with non-Sony equipment.
 - Scene Select
 - Home Theater Control
- Equipment not compatible with “BRAVIA” Sync can not activate these features.

Preparing for the “BRAVIA” Sync

To use the “BRAVIA” Sync, turn the Control for HDMI function on for both the receiver and the connected equipment.

Turn the Control for HDMI function of the receiver and the connected equipment on individually.

- 1 Select “Settings” from the home menu, then press .**
- 2 Select “HDMI Settings,” then press .**
- 3 Select “Control for HDMI,” then press .**
- 4 Select “On,” then press .**
The Control for HDMI function of the receiver is activated.
- 5 Turn the Control for HDMI function of the connected equipment on.**

For details on setting the connected equipment, refer to its operating instructions.

6 Repeat step 5 to set the Control for HDMI function and to display the image of all the playback equipment you want to use.

Note

When you pull out the HDMI cable or change the connection, perform the steps above.

However, you do not need to perform these steps when you use an HDMI IN 1, IN 2, or IN 6 jack.

System Power-Off

When you turn the TV off, using the power button on the TV's remote control, the receiver and the connected equipment turn off automatically.

You can also use the remote control to turn off the TV.

Press TV, then press AV I/⏻.

The TV, receiver and connected equipment are turned off.

Notes

- Set the TV power supply interlock function to on before using the System Power-Off function. For details, refer to the operating instructions of the TV.
- Depending on the condition of the connected equipment, the connected equipment may not be turned off. For details, refer to the operating instructions of the connected equipment.
- If you use the System Power-Off function with a non-Sony TV, program the remote control according to the maker of the TV.

One-Touch Play

When you play back content on the equipment connected to the receiver via an HDMI connection, the receiver is also turned on automatically and is switched to the appropriate HDMI input.

When you set "Pass Through" to "On," sound and image can be output only from the TV while the receiver remains in standby mode.

Start playback on the playback equipment.

To use the One-Touch Play function of the camcorder

- 1 Turn the Control for HDMI function on for both the receiver and your camcorder.
- 2 Connect your camcorder to one of the HDMI IN 1, IN 2, or IN 6 jacks (page 37).

If you use a Sony camcorder, the TV is turned on in conjunction with the receiver, then the camcorder starts playback automatically. If you use a non-Sony camcorder, play back the camcorder continuously.

Notes

- Depending on the TV, the start of the content may not appear.
- Connect equipment such as a Sony camcorder equipped with the One-Touch Play function simply by making an HDMI connection to the HDMI IN 1, IN 2, or IN 6 jack. If you use other HDMI IN jacks, the receiver may not be switched to an appropriate input. In this case, manually select the input to which the camcorder is connected.

System Audio Control

You can enjoy the TV sound from the speakers connected to the receiver by a simple operation. You can also adjust the volume and turn off the sound of the receiver using the TV's remote control.

You can use the System Audio Control function as follows.

- The sound of the TV is output from the speakers connected to the receiver when you turn the receiver on while the sound is being output from the TV speaker. If you turn off the receiver, the sound is output from the TV speaker.
- When you adjust the TV volume, the System Audio Control function adjusts the receiver's volume simultaneously.

You can also operate this function using the TV menu. For details, refer to the operating instructions of the TV.

Notes

- When “Control for HDMI” is set to “On,” the “Audio Out” settings in the HDMI Settings menu will set automatically based on the System Audio Control settings.
- If the TV is turned on before turning on the receiver, the TV will momentarily lose the sound output.

Audio Return Channel (ARC)

If the TV is compatible with the Audio Return Channel (ARC), an HDMI cable connection also sends a digital audio signal from the TV to the receiver. You do not need to make a separate audio connection for listening to TV sound from the receiver.

For details, see “Switching between digital and analog audio” (page 88).

Scene Select

The optimum picture quality and sound field are selected automatically according to the scene selected on your TV.

For details on the operation, refer to the operating instructions of the TV.

Note

The sound field may not switch depending on the TV.

Correspondence table

Scene setting on the TV	Sound field
Cinema	HD-D.C.S.
Sports	SPORTS
Music	Live Concert
Animation	A.F.D. Auto
Photo	A.F.D. Auto
Game	A.F.D. Auto
Graphics	A.F.D. Auto

Home Theater Control

If a “Home Theater Control”-compatible TV is connected to the receiver, an icon for Internet based applications appears on the connected TV.

You can switch an input of the receiver or switch sound fields by using your TV’s remote control. You can also adjust the level of the center speaker or the subwoofer, or adjust the settings of “Sound Optimizer” (page 76), “Dual Mono” (page 107), or “A/V Sync” (page 108).

To use the Home Theater Control function, your TV must be able to access a broadband service.

For details, refer to the operating instructions supplied with your TV.

Switching the monitors that output the HDMI video signals

When you have two monitors connected to the HDMI OUT A and HDMI OUT B jacks, you can switch the output for these two monitors using the HDMI OUTPUT button on the remote control.

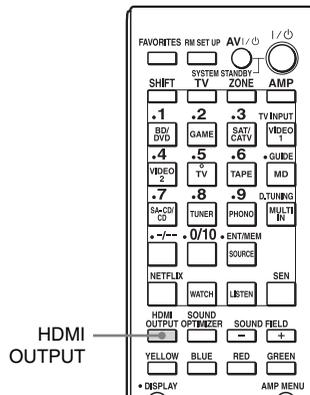

1 Turn on the receiver and the two monitors.

2 Press **HDMI OUTPUT**.

Each time you press the button, the output will be switched as follows:

HDMI A → HDMI B → HDMI A + B
→ OFF → HDMI A...

You can also use the HDMI OUT button on the receiver.

Notes

- If the compatible video format differs between the monitors connected to the HDMI OUT A jack and the HDMI OUT B jack of the receiver, “HDMI A + B” may not work.
- Depending on the playback equipment you connect, “HDMI A + B” may not work.

Outputting the HDMI signals even when the receiver is in standby mode

(Pass Through)

You can output the video and audio signals from the HDMI IN jack to the TV connected to the HDMI OUT A jack even when the receiver is in standby mode.

If you use this function while “Control for HDMI” is set to “On,” the input of the receiver is switched in accordance with the operation of the connected equipment, even when the receiver is in standby mode.

When you activate this function, make the settings for “Pass Through” following the steps below.

1 Select “Settings” from the home menu, then press **⊕**.

2 Select “HDMI Settings,” then press **⊕**.

3 Select “Pass Through,” then press **⊕**.

4 Select the parameter you want, then press **⊕**.

Parameter	Explanation
On	When the receiver is in the standby mode, the receiver outputs HDMI signals from the receiver’s HDMI OUT A jack.
Off	The receiver does not output HDMI signals when in the standby mode. Turn on the receiver to enjoy the connected equipment’s source on the TV. This setting saves power in the standby mode, compared with the “On” setting.

Switching between digital and analog audio

When you connect equipment to both digital and analog audio input jacks on the receiver, you can fix the audio input mode to either of them, or switch from one to the other, depending on the type of material you intend to watch.

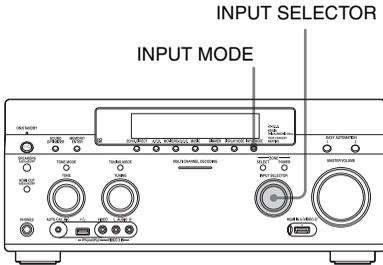

1 Select the input source using **INPUT SELECTOR** on the receiver.

2 Press **INPUT MODE** on the receiver.

The selected audio input mode appears in the display window.

- **AUTO**

Gives priority to digital audio signals when there are both digital and analog connections.

If there are no digital audio signals, analog audio signals are selected.

When TV input is selected, priority is given to the Audio Return Channel (ARC) signals. If your TV is not compatible with the Audio Return Channel (ARC), the digital optical audio signals are selected.

If the Control for HDMI functions of both the receiver and the TV are not activated, the Audio Return Channel (ARC) does not work.

- **OPT**

Appears only when an optical jack is assigned to the input and selects the optical input jack automatically.

- **COAX**

Appears only when a coaxial jack is assigned to the input and selects the coaxial input jack automatically.

- **ANALOG**

Specifies the analog audio signals input to the AUDIO IN (L/R) jacks.

Notes

- Based on the input, “-----” appears on the display window, and other modes cannot be selected.
- When “2ch Analog Direct” is being used, or “MULTI IN” is selected, audio input is set to “Analog.” You cannot select other modes.

Using other video/audio input jacks

You can reassign video and/or audio signals to another input jacks.

Example) Connect the OPTICAL OUT jack of the DVD player to the OPTICAL IN 1 jack of this receiver when you want to input the only digital optical audio signals from the DVD player.

Connect the component video jack of the DVD player to the COMPONENT VIDEO IN 1 or COMPONENT VIDEO IN 2 jacks of this receiver when you want to input the video signals from the DVD player.

1 Select “Settings” from the home menu, then press **+**.

2 Select “Input Settings,” then press **+**.

3 Select “Video Input Assign” or “Audio Input Assign,” then press **+**.

4 Select the audio and/or video signals you want to assign to each input.

Notes

- If you assign an input to any of the HDMI IN 1 to IN 6 jacks in “Video Input Assign” or “Audio Input Assign,” the same HDMI input jack is assigned to both the video input and audio input. If you want to assign an HDMI IN jack to either the video input or audio input, first assign an input to any of the HDMI IN 1 to IN 6 jacks in “Video Input Assign” or “Audio Input Assign.” Then, set the assignment of an HDMI IN jack to “None” in either “Video Input Assign” or “Audio Input Assign,” for whichever one you do not want to assign an HDMI IN jack to.
- When you operate the receiver without using the GUI, you can change the assignment of an HDMI IN jack using “HDMI VIDEO ASSIGN ?” or “HDMI AUDIO ASSIGN ?” in “INPUT SETTINGS” (page 124).
- If you change the assignment of an HDMI IN jack while the Control for HDMI function is being used, switch the input of the receiver to the input to which the HDMI equipment is connected. Otherwise the Control for HDMI function may not work properly.
- If you set the assignment of an HDMI IN jack to “NONE” in both “Video Input Assign” and “Audio Input Assign,” you can not select the input signals via the HDMI input. In this case, the Control for HDMI function works only on equipment other than the receiver. However, this is not malfunction.

Input name		BD/DVD	GAME	SAT/CATV	VIDEO 1	VIDEO 2	TV	TAPE	MD	SA-CD/CD	PHONO	MULTI IN
Assignable video input jacks	Component1 (BD/DVD)	○*	○	○	○	○	-	○	○	○	-	○
	Component2 (SAT/CATV)	○	○	○*	○	○	-	○	○	○	-	○
	HDMI1 (GAME)	○	○*	○	○	○	-	○	○	○	-	○
	HDMI2 (SAT/CATV)	○	○	○*	○	○	-	○	○	○	-	○
	HDMI3 (SA-CD/CD)	○	○	○	○	○	-	○	○	○*	-	○
	HDMI4 (BD/DVD)	○*	○	○	○	○	-	○	○	○	-	○
	HDMI5 (VIDEO 1)	○	○	○	○*	○	-	○	○	○	-	○
	HDMI6 (VIDEO 2)	○	○	○	○	○*	-	○	○	○	-	○
Assignable audio input jacks	Optical1 (GAME)	○	○*	○	○	○	-	○	○	○	-	-
	Optical2 (SAT/CATV)	○	○	○*	○	○	-	○	○	○	-	-
	Optical3 (TV)	○	○	○	○	○	○*	○	○	○	-	-
	Optical4 (MD)	○	○	○	○	○	-	○	○*	○	-	-
	Coaxial1 (BD/DVD)	○*	○	○	○	○	-	○	○	○	-	-
	Coaxial2 (VIDEO 1)	○	○	○	○*	○	-	○	○	○	-	-
	Coaxial3 (SA-CD/CD)	○	○	○	○	○	-	○	○	○*	-	-
	HDMI1 (GAME)	○	○*	○	○	○	-	○	○	○	-	-
	HDMI2 (SAT/CATV)	○	○	○*	○	○	-	○	○	○	-	-
	HDMI3 (SA-CD/CD)	○	○	○	○	○	-	○	○	○*	-	-
	HDMI4 (BD/DVD)	○*	○	○	○	○	-	○	○	○	-	-
	HDMI5 (VIDEO 1)	○	○	○	○*	○	-	○	○	○	-	-
	HDMI6 (VIDEO 2)	○	○	○	○	○*	-	○	○	○	-	-

* factory default setting

Notes

- When you assign the digital audio input, the INPUT MODE setting may change automatically.
- When you assign a video input to the component or composite input, and an audio input to the HDMI input, component or composite video signals are not output from the HDMI OUT jacks. Component or composite video signals are output from the COMPONENT VIDEO MONITOR OUT jacks or the MONITOR VIDEO OUT jack.
- You cannot assign different HDMI jacks to separate video and audio input jacks of an input.
- You can assign multiple inputs with the same HDMI IN jack. However, if you use the One-Touch Play function on the equipment connected to the HDMI IN jack, the previous input, in its original input sequence, is preferentially selected.

Operating the receiver using a smartphone

You can operate the receiver using a smartphone equipped with the “ES Remote” application software. The “ES Remote” application software can be downloaded from the App Store (for iPhone) or the Android Market (for Android phone) for free.

Saving various settings for the receiver and recalling those settings all at one time (Easy Automation)

You can save various settings with the receiver all at one time, and recall the settings and apply them to the receiver easily. For example, by saving the settings in the “1: Movie” scene as follows, you can switch the settings of the receiver all at one time by a simple, one-touch operation without switching each setting for “Input,” “Calibration Type,” “Sound Field,” and “HDMI Out,” individually.

Setting item	Value set for “1: Movie”
Input	BD/DVD
Calibration Type	Engineer
Sound Field	HD-D.C.S.
HDMI Out	HDMI OUT B

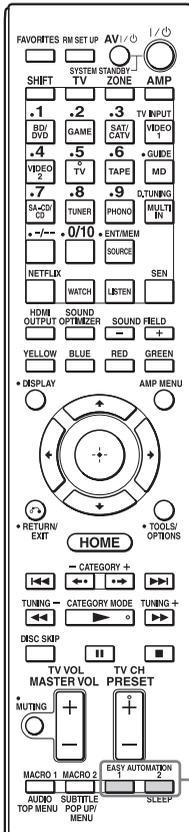

EASY
AUTOMATION

The items for which you can save settings and the default values for each item are as follows.

Setting item	Default value			
	1: Movie	2: Music	3: Party	4: Night
Input	BD/DVD	SA-CD/ CD	No Change	No Change
Tuner Preset	No Change	No Change	No Change	No Change
Sound Field	HD- D.C.S.	Berlin Philharmonic Hall	Multi Stereo	No Change
Sleep	No Change	No Change	Off	30 min.
Volume	No Change	No Change	-10 dB	-30 dB
HDMI Out	No Change	No Change	No Change	No Change
Speaker	No Change	No Change	No Change	No Change
Party Mode	No Change	No Change	On	No Change
A/V Sync	No Change	No Change	No Change	No Change
Calibration Type	No Change	No Change	No Change	No Change
Digital Legato Linear	No Change	No Change	No Change	No Change
Sound Optimizer	No Change	No Change	Off	On
Sound Field Mode	No Change	No Change	No Change	No Change
Equalizer (Front)	No Change	No Change	No Change	No Change
Equalizer (Center)	No Change	No Change	No Change	No Change
Equalizer (Surround)	No Change	No Change	No Change	No Change
Equalizer (Front High)	No Change	No Change	No Change	No Change

* You can select “Tuner Preset” only when “FM,” “AM,” or “SIRIUS” is selected for “Input.”

Recall the settings saved to the Scene

- 1 Select “Easy Automation” from the home menu, then press **⊕**.
- 2 Select a Scene you want, then press **⊕**.

Save the settings to a Scene

- 1 Select “Easy Automation” from the home menu, then press **⊕**.
- 2 Select a Scene for which you want to save settings among from “1: Movie,” “2: Music,” “3: Party,” or “4: Night,” then press **TOOLS/OPTIONS**.
- 3 Select the menu you want, then press **⊕**.

Menu	Explanation
Edit Saved Scene	Allows you to customize and save the settings to suit your preferences.
Import Current Settings	Loads the present settings of the receiver and saves those settings with the Scene. “Input” and “Volume” are set to “No Change.”

Notes

- Settings items saved as “No Change” are not changed from the present settings even when you recall the Scene. Select “Edit Saved Scene,” then uncheck the box for a setting item on the edit screen to set “No Change.”
- When you recall the Scene, the settings that cannot be applied are ignored (e.g., the value for “Sound Field” when “MULTI IN” is selected, etc.).

Tip

You can recall the setting(s) saved for “1: Movie” or “2: Music” directly by pressing EASY AUTOMATION 1 or EASY AUTOMATION 2 on the receiver or the remote control. You can also overwrite “1: Movie” or “2: Music” with the present settings by holding down EASY AUTOMATION 1 or EASY AUTOMATION 2 for 3 seconds in the same way as you do when you select “Import Current Settings” from the menu.

Using the sleep timer

You can set the receiver to turn off automatically at a specified time.

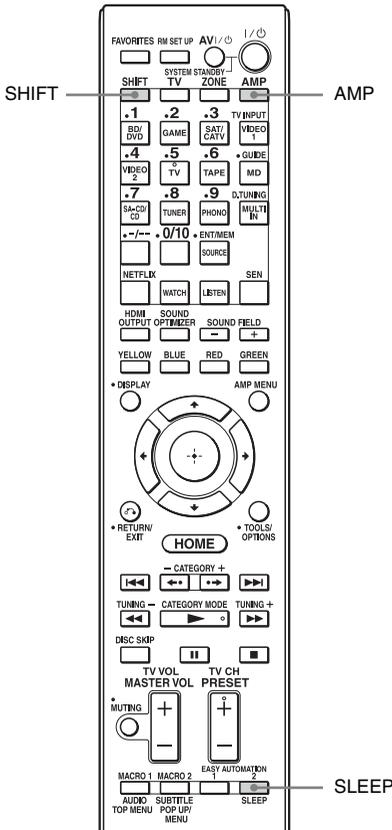

0:30:00 → 1:00:00 → 1:30:00 → 2:00:00 → OFF

When sleep timer is being used, “SLEEP” lights up in the display window of the receiver.

To check the remaining time before the receiver turns off, press SLEEP. The remaining time appears on the display window. If you press SLEEP again, the sleep timer is set to “OFF.”

Recording using the receiver

You can record from a video/audio equipment using the receiver. Refer to the operating instructions supplied with your recording equipment.

Recording with a video equipment

- 1 Select “Watch” from the home menu, then press \oplus .
- 2 Select the playback equipment, then press \oplus .
- 3 Prepare the equipment for playing.

For example, insert the video tape you want to copy into the VCR.

- 4 Prepare the recording equipment.
Insert a blank video tape, etc., into the recording equipment (VIDEO 1) for recording.
- 5 Start recording on the recording equipment, then start the playback equipment.

1 Press AMP.

The receiver can be operated using the remote control.

2 Press SHIFT, then press SLEEP.

Each time you press SLEEP, the display changes cyclically as follows:

Switching the command mode of the multifunction remote control

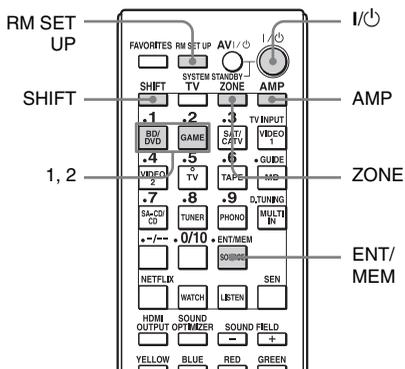

- 1 Press I/⏻ while pressing RM SET UP.

The AMP and ZONE buttons flash.

- 2 Press AMP.

The ZONE button goes off, the AMP button keeps flashing and the SHIFT button lights up.

- 3 Press the numeric button 1 or 2 while the AMP button is flashing.

When you press 1, the command mode is set to COMMAND MODE AV1. When you press 2, the command mode is set to COMMAND MODE AV2.

The AMP button lights up.

- 4 Press ENT/MEM.

The AMP button flashes twice, then the command mode setting process is completed.

Switching the command mode of the simple remote control

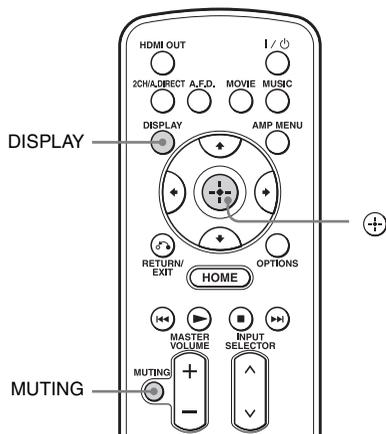

- Press MUTING and the directional pad button at the same time while pressing DISPLAY.

Using a bi-amplifier connection

If you are not using surround back speakers and front high speakers, you can use the SURROUND BACK (ZONE 2) terminals for the front speakers for use with a bi-amplifier connection.

To connect speakers

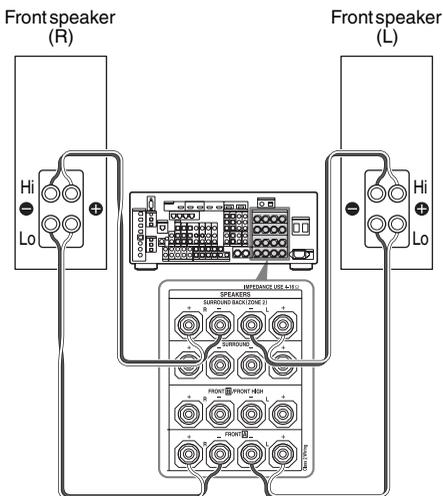

Connect the jacks on the Lo (or Hi) side of the front speakers to the FRONT **A** terminals, and connect the jacks on the Hi (or Lo) side of the front speakers to the SURROUND BACK (ZONE 2) terminals. Make sure that metal fittings of Hi/Lo attached to the speakers have been removed from the speakers to avoid receiver malfunction.

To set up speakers

For details, see “Speaker Connection” in the Speaker Settings menu (page 104).

Notes

- You cannot use the FRONT **B**/FRONT HIGH terminals for a bi-amplifier connection.
- Make the bi-amplifier settings before you perform the Auto Calibration function.

- If you make the bi-amplifier settings, the speaker level, balance, and equalizer settings of the surround back speakers become invalid, and those of the front speakers are used.
- Signals output from the PRE OUT jacks are used with the same settings as those of the SPEAKERS terminals.
- If the speaker pattern is set so that there are surround back speakers or front high speakers, you cannot set the SURROUND BACK (ZONE 2) terminals for a bi-amplifier connection.
- When you operate the receiver without using the GUI, set “SB ASSIGN” to “BI-AMP” in “SPEAKER SETTINGS” (page 123).

Adjusting Settings

Using the setting menu

You can adjust the various settings for speakers, surround effects, multi-zone, etc., using the setting menu.

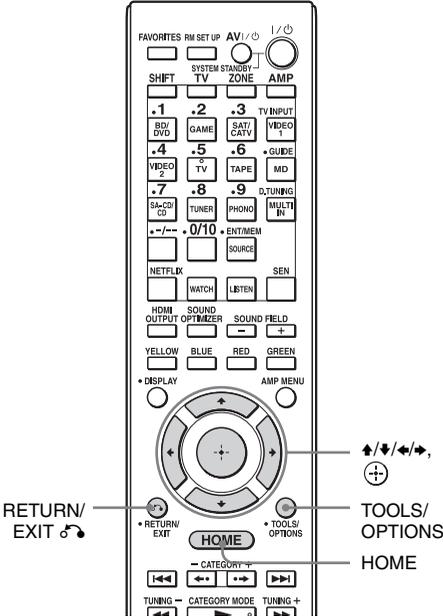

- 1** Select “Settings” from the home menu, then press **+** to enter the menu mode.

The setting menu list appears on the TV screen.

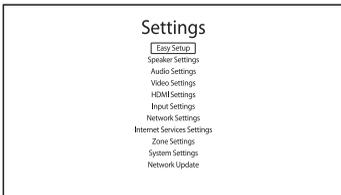

- 2** Select the menu item you want, then press **+** to access the menu item.

Example: When you select “Audio Settings.”

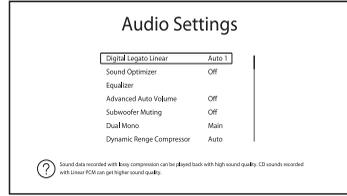

- 3** Select the parameter you want, then press **+** to enter.

To return to the previous screen
Press RETURN/EXIT

To exit the menu
Press HOME.

Setting menu list

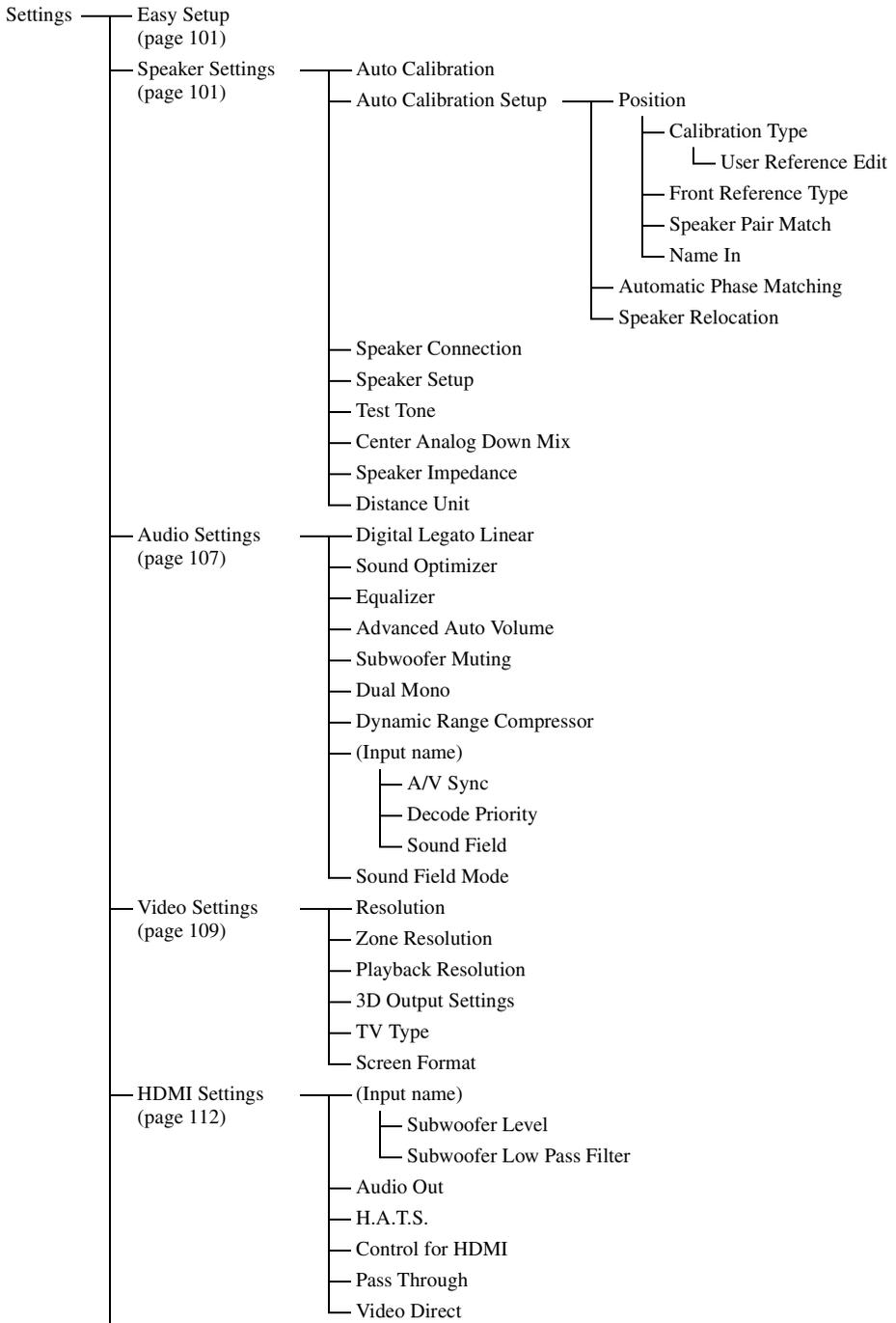

Input Settings (page 114)	Input Edit
	Audio Input Assign
	Video Input Assign
Network Settings (page 115)	Internet Settings
	Connection Server Settings
	Renderer Options
	Renderer Access Control
	External Control
	Network Standby
Internet Services Settings (page 115)	Parental Control Password
	Parental Control Area Code
	Internet Video Parental Control
	Internet Video Unrated
Zone Settings (page 116)	Zone Control
	Zone Setup
System Settings (page 118)	Language
	Auto Standby
	Settings Lock
	RS232C Control
	Software Update Notification
	Initialize Personal Information
	System Information
	EULA
Network Update (page 119)	

Easy Setup

Re-runs the Easy Setup to make the basic settings. Follow the on-screen instructions (page 49).

Speaker Settings

You can set up your viewing environment (with the speaker system you are using) either automatically or manually.

Auto Calibration

Performs the D.C.A.C. (Digital Cinema Auto Calibration) function. This function allows you to perform automatic calibration, such as checking the connection between each speaker and the receiver, adjusting the speaker level, and measuring the distance of each speaker from your seating position automatically.

Note

The measurement results will be overwritten and saved on the currently selected position.

Auto Calibration Setup

Lets you register three patterns for “Position,” depending on the seating positions, listening environment, and measurement conditions. You can also select a calibration type to compensate the each speaker.

Position

You can register more than one set of settings for the listening environment or recall a set of settings.

Select the “Position” for which you want to register the measurement results on the Auto Calibration Setup screen.

- Pos.1
- Pos.2
- Pos.3

To set a compensation type for the speakers

You can select the compensation type to be used for the speakers for each Position.

- 1 Select the “Position” for which you want to set the speaker compensation type, then press .
- 2 Select the “Calibration Type” you want, then press .
 - Full Flat
Makes the measurement of frequency from each speaker flat.
 - Engineer
Sets the frequency to match that of the Sony listening room standard.
 - Front Reference
Adjusts the characteristics of all the speakers to match the characteristics of the front speakers.
 - User Reference
Sets the frequency to one that you customized using “User Reference Edit.”
 - Off
Sets the Auto Calibration EQ to off.

Note

You cannot set the “Calibration Type” for “Position” for which the measurement results have not been registered.

To set the reference value when you select “Front Reference” for the “Calibration Type”

- 1 Select the “Front Reference Type” in the Calibration Type menu, then press .
- 2 Select the parameter you want, then press .
 - L/R
Sets the data of the left and right channels to the reference value.
 - L
Sets the data of the left channel to the reference value.
 - R
Sets the data of the right channel to the reference value.

Notes

- This function works only when you select “Front Reference” for the “Calibration Type” (page 101).
- Perform “Auto Calibration” after you set “Front Reference Type.”

To customize the frequency for the “User Reference”

You can customize the frequency for the “User Reference” in the “Calibration Type” based on the “Full Flat” compensation type.

- 1 Select the “User Reference Edit” in the Calibration Type menu, then press .
- 2 Adjust the frequency.

To set the pair match mode for the Auto Calibration EQ pattern

- 1 Select the “Position” for which you want to set the pair match mode, then press .
- 2 Select “Speaker Pair Match,” then press .
 - All
Calibrates all the speakers using the pair match processing of the left and right channels for each pair of speakers.
 - Sur
Calibrates the surround speakers and the surround back speakers using the pair match processing of the left and right channels for each pair of speakers.
 - Off
Calibrates each speaker individually.

Notes

- This function does not work when “Auto Calibration” is not performed.
- You cannot set “SP Pair Matching” to “ALL” when you select “Front Reference” for the “Calibration Type” (page 102).

To name the Position

- 1 Select the “Position” for which you want to name, then press .
- 2 Select “Name In,” then press .
The soft keyboard appears on the screen.

3 Press $\uparrow/\downarrow/\leftarrow/\rightarrow$ and \oplus to select a character one by one.

4 Select "Finish," then press \oplus .

Automatic Phase Matching

Lets you set the A.P.M. (Automatic Phase Matching) function in the D.C.A.C. (Digital Cinema Auto Calibration) function (page 101).

Calibrates the phase characteristics of the speakers and ensures a well-coordinated surround space.

■ Off

Does not activate the A.P.M. function.

■ Auto

Switches the A.P.M. function on or off automatically.

Notes

- This function does not work in the following cases.
 - "Off" is selected for the calibration type (page 101).
 - "MULTI IN" is selected.
 - "2ch Analog Direct" is being used.
- The receiver may play back signals at a lower sampling frequency than the actual sampling frequency of the input signals, depending on the audio format.

Speaker Relocation

Lets you calibrate speaker positioning (configuration angle of each speaker from the measurement position) to improve the surround effect.

■ Type A

Places surround back speakers on the back wall in addition to those speakers in Recommendation ITU-R for 5.1 channel speaker placement.

Drawing of the relocated speaker placement

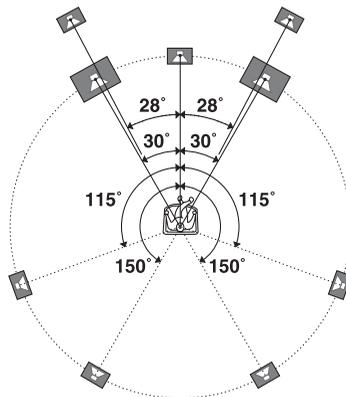

■ Type B

Places four surround speakers at virtually identical angles, according to Recommendation ITU-R for 7.1 channel speaker placement.

Drawing of the relocated speaker placement

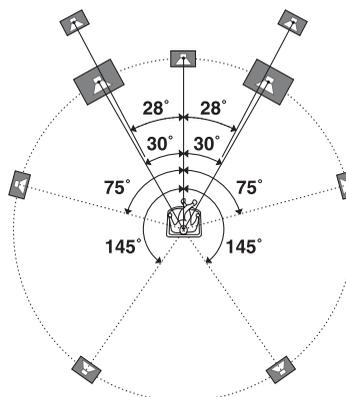

■ Off

Does not relocate speaker positioning.

Note

This function does not work when you set "Calibration Type" (page 102) or "Automatic Phase Matching" (page 103) to "Off."

Speaker Connection

Lets you adjust each speaker manually. You can also adjust the speaker levels after the Easy Setup is completed.

The Speaker Settings are only for the current “Position.”

You can make the following settings using the wizard.

- Settings for the speaker pattern for the speaker system you are using
- Settings for the SURROUND BACK (ZONE 2) terminals for a bi-amplifier connection or a zone 2 connection (“SB Assign”)
- Settings that determine whether signals for the surround back channel are output to the SURROUND BACK (ZONE 2) terminals or the PRE OUT SUR BACK jacks
- Settings that determine whether signals for the front high channel are output to the FRONT [B]/FRONT HIGH speaker terminals or PRE OUT FRONT HIGH jacks

Note

If the speaker pattern is set so that there are surround back speakers or front high speakers, you cannot set the SURROUND BACK (ZONE 2) terminals for a bi-amplifier connection or a zone 2 connection.

Speaker Setup

Lets you adjust each speaker manually on the Manual Setup screen. You can also adjust the speaker levels after “Auto Calibration” is completed.

Select “Level/Distance/Size,” then press \oplus .

To adjust the speaker level

You can adjust each speaker’s level (center, surround left/right, surround back left/right, front high left/right, subwoofer).

- 1 Select the speaker on the screen for which you want to adjust the level, then press \oplus .

- 2 Select “Level,” then press \oplus .

You can adjust the level from -20 dB to $+10$ dB in 0.5 dB intervals.

For the front left/right speakers, you can adjust the balance on either side. You can adjust the front left level from FL -10.0 dB to FL $+10.0$ dB in 0.5 dB intervals. You can also adjust the front right level from FR -10.0 dB to FR $+10.0$ dB in 0.5 dB intervals.

To adjust the distance from the seating position to each speaker

You can adjust the distance from the seating position to each speaker (front left/right, center, surround left/right, surround back left/right, front high left/right, subwoofer.)

- 1 Select the speaker on the screen for which you want to adjust the distance, then press \oplus .

- 2 Select a “Distance,” then press \oplus .

You can adjust the distance from 1.0 meter to 10.0 meters (3 feet 3 inches to 32 feet 9 inches) in 1 cm (1 inch) intervals.

To adjust the size of each speaker

You can adjust each speaker’s (front left/right, center, surround left/right, surround back left/right, front high left/right) size.

- 1 Select the speaker on the screen for which you want to adjust the size, then press \oplus .

- 2 Select a “Size,” then press \oplus .

- Large

If you connect large speakers that will effectively reproduce bass frequencies, select “Large.” Normally, select “Large.”

- **Small**
If the sound is distorted, or you feel a lack of surround effects when using multi-channel surround sound, select “Small” to activate the bass redirection circuitry and output the bass frequencies of each channel from the subwoofer or other “Large” speakers.

Notes

- The surround back speakers will be set to the same setting as that of the surround speakers.
- When the front speakers are set to “Small,” the center, surround, surround back, and front high speakers are also automatically set to “Small.”
- If you do not use the subwoofer, the front speakers are automatically set to “Large.”

To adjust the crossover frequency of each speaker

Lets you set the bass crossover frequency of speakers that has been set to “Small” in the Size menu. Measured speaker crossover frequency is set for each speaker after “Auto Calibration.”

- 1 Select “Crossover Frequency,” then press .
- 2 Select the speaker on the screen for which you want to adjust the crossover frequency.
- 3 Set the crossover frequency of the selected speaker.

Note

The surround back speakers will be set to the same setting as that of the surround speakers.

To adjust the level of the rear speakers

You can adjust the level of the rear speakers (surround speakers and surround back speaker(s)) in contrast to the level of the front speakers all at one time.

- 1 Select “All Surround Level,” then press .
- 2 Adjust the level of the rear speakers.

You can adjust the level from -5 dB to +5 dB in 1 dB intervals.

Test Tone

Lets you select the test tone type on the Test Tone screen.

To output a test tone from each speaker

You can output a test tone from the speakers in sequence.

- 1 Select “Test Tone,” then press .
The Test Tone screen appears.
- 2 Adjust the parameter, then press .
 - Off
 - Auto
The test tone is output from each speaker in sequence.
 - L, C, R, SR, SB*, SBR, SBL, SL, LH, RH, SW
* “SB” appears when only one surround back speaker is connected.

You can select which speakers will output the test tone.
- 3 Adjust “Level,” then press .

To output a test tone from adjacent speakers

You can output a test tone from adjacent speakers so that you can adjust the balance between the speakers.

- 1 Select “Phase Noise,” then press .
The Phase Noise screen appears.
- 2 Adjust the parameter, then press .
 - Off
 - L/R, L/C, C/R, R/SR, SR/SBR, SR/SB*, SBR/SBL, SR/SL, SB/SL*, SBL/SL, LH/RH, SL/L, L/SR, SL/R, L/RH, LH/R
* “SR/SB” and “SB/SL” appear when only one surround back speaker is connected.

Lets you output the test tone sequentially from adjacent speakers.
Some items may not be displayed, depending on the setting of the speaker pattern.

3 Adjust “Level,” then press \oplus .

To output the source sound from adjacent speakers

You can output the source sound from adjacent speakers so that you can adjust the balance between the speakers.

1 Select “Phase Audio,” then press \oplus .
The Phase Audio screen appears.

2 Adjust the parameter, then press \oplus .

- Off
- L/R, L/C, C/R, R/SR, SR/SBR, SR/SB*, SBR/SBL, SR/SL, SB/SL*, SBL/SL, LH/RH, SL/L, L/SR, SL/R, L/RH, LH/R

*“SR/SB” and “SB/SL” appear when only one surround back speaker is connected.

Lets you output front 2 channel source sound (instead of the test tone) sequentially from adjacent speakers.
Some items may not be displayed, depending on the setting of the speaker pattern.

3 Adjust “Level,” then press \oplus .

Center Analog Down Mix

Lets you set the analog downmix settings on or off.

■ Off

If the speaker pattern is set so that there is a center speaker, this setting is set to “Off” automatically.

■ On

We recommend you set “Center Analog Down Mix” to “On” to enjoy digital audio with high quality sound when you do not have a center speaker connected. Analog downmix works when you set “Center Analog Down Mix” to “On.” This setting is also effective to input signals from the MULTI CHANNEL INPUT jacks.

Speaker Impedance

Lets you set the speaker impedance. For details, see “7: Setting up the receiver using the Easy Setup” (page 49).

■ 4 Ω

■ 8 Ω

Distance Unit

Lets you select the unit of measurement for setting distances.

■ meter

The distance is displayed in meters.

■ feet

The distance is displayed in feet.

Audio Settings

You can adjust settings for the audio to suit your preference.

Digital Legato Linear (D.L.L.)

The D.L.L. function is Sony proprietary technology that allows low quality digital audio signals and analog audio signals to be played back with high quality sound.

■ Off

■ Auto 1

This function is available for lossy compression audio formats and analog audio signals.

■ Auto 2

This function is available for Linear PCM signals, as well as lossy compression audio formats and analog audio signals.

Notes

- This function may not work, depending on the content via a USB device, or a home network.
- This function works when “A.F.D. Auto” is selected. However, this function does not work in the following cases.
 - Linear PCM signals with a sampling frequency of other than 44.1 kHz are being received.
 - Dolby Digital Plus, Dolby Digital EX, Dolby TrueHD, DTS 96/24, DTS-ES Matrix 6.1, DTS-HD Master Audio, or DTS-HD High Resolution Audio signals are being received.

Sound Optimizer

Lets you turn the sound optimizer function on or off (page 76).

■ Off

■ On

Equalizer

Lets you adjust the bass and treble level for each speaker (page 77).

Advanced Auto Volume

Lets you turn the Advanced Auto Volume function on or off (page 77).

■ Off

■ On

Subwoofer Muting

Lets you prevent signals from being output via the PRE OUT SUBWOOFER jacks.

■ Off

The PRE OUT SUBWOOFER jacks output signals.

■ On

The PRE OUT SUBWOOFER jacks do not output signals.

Dual Mono

Lets you select the language you want when you listen to the dual audio of a digital broadcast when available. This feature only functions for Dolby Digital sources.

■ Main/Sub

Sound of the main language will be output through the front left speaker, and sound of the sub language will be output through the front right speaker simultaneously.

■ Main

Sound of the main language will be output.

■ Sub

Sound of the sub language will be output.

Dynamic Range Compressor

Lets you compress the dynamic range of the soundtrack. This may be useful when you want to watch movies at low volumes late at night. Dynamic range compression is possible with Dolby Digital sources only.

■ Off

The dynamic range is not compressed.

■ Auto

The dynamic range is compressed automatically.

■ On

The dynamic range is compressed as intended by the recording engineer.

A/V Sync (Synchronizes audio and video output)

Lets you delay the output of audio to minimize the time gap between audio output and visual display.

This function is useful when you use a large LCD or plasma monitor or a projector. You can set the function for each input independently.

■ HDMI Auto

The time gap between audio output and visual display for the monitor connected via an HDMI connection will be adjusted automatically based on the information for the TV. This feature is available only when the monitor supports the A/V Sync function.

■ 0 ms – 1200 ms

You can adjust the delay from 0 ms to 1200 ms* in 10 ms intervals.

* The maximum delay may be limited to the lower value, depending on the audio stream.

Note

- This function does not work in the following cases.
 - “MULTI IN” is selected.
 - “2ch Analog Direct” is being used.

Decode Priority (Digital audio input decoding priority)

Lets you specify the input mode for the digital signal input to the DIGITAL IN jacks or HDMI IN jacks.

You can set the function for each input independently.

■ PCM

When signals from the DIGITAL IN jack are selected, PCM signals are given priority (to prevent interruption when playback starts). However, when other signals are input, there may be no sound, depending on the format. In this case, set this item to “Auto.”

When signals from the HDMI IN jack are selected, only PCM signals are output from the connected player. When signals in any other format are received, set this item to “Auto.”

■ Auto

Automatically switches the input mode between Dolby Digital, DTS, or PCM.

Note

Even when “Decode Priority” is set to “PCM,” the start of the sound may not be output due to signals on the CD being played back.

Sound Field

Lets you select a sound effect applied to input signals. For details, see “Enjoying Sound Effects” (page 71).

You can set the function for each input independently.

Sound Field Mode

Lets you set whether or not to output sound from the front high speakers. For details, see “Sound Field Mode” (page 75).

Video Settings

You can adjust settings for video.

Resolution (Converting video signals)

Lets you convert the resolution of analog video input signals and output the converted signals.

■ Direct

Lets you output analog video input signals directly.

■ 480p/576p

■ 720p

■ Auto

■ 1080i

■ 480i/576i

■ 1080p

"Resolution" menu setting	Output from		HDMI OUT jacks	MONITOR COMPONENT VIDEO OUT jacks	MONITOR VIDEO OUT jack
	Input from				
Direct	COMPONENT VIDEO IN jacks		–	○	–
	VIDEO IN jacks		–	–	○
Auto (factory default setting)	COMPONENT VIDEO IN jacks		● ^{a)}	● ^{b)}	● ^{b)}
	VIDEO IN jacks			● ^{b)}	● ^{b)}
480i/576i	COMPONENT VIDEO IN jacks		● ^{c)}	●	●
	VIDEO IN jacks		● ^{c)}	●	●
480p/576p	COMPONENT VIDEO IN jacks		●	●	–
	VIDEO IN jacks		●	●	○
720p, 1080i	COMPONENT VIDEO IN jacks		●	● ^{d)}	–
	VIDEO IN jacks		●	● ^{d)}	○
1080p	COMPONENT VIDEO IN jacks		●	○	–
	VIDEO IN jacks		●	–	○

● : Video signals are converted and output through the video converter.

○ : The same type of signal as that of the input signal is output. Video signals are not converted.

– : Video signals are not output.

^{a)}The resolution is set automatically, depending on the connected monitor.

^{b)}When the TV is connected to jacks other than the HDMI jacks, 480i/576i signals are output when "Resolution" is set to "Auto."

- c) 480p/576p signals are output even if 480i/576i is set.
- d) Video signals without copyright protection are output based on the settings menu. Video signals with copyright protection are output as 480p/576p.

Notes

- Video signals are not output from the COMPONENT VIDEO MONITOR OUT or MONITOR VIDEO OUT jacks when the monitor, etc., is connected to HDMI OUT jacks.
- If you select a resolution which the connected TV does not support in the “Resolution” menu, the images from the TV cannot be output correctly.
- Converted HDMI image output does not support x.v.Color, Deep Color and 3D.

Zone Resolution

Lets you convert the resolution of analog video input signal in zone 2.

■ 480i/576i

■ 720p

■ 480p/576p

■ 1080i

“Zone Resolution” menu setting	Output from		ZONE 2 COMPONENT VIDEO OUT jacks	ZONE 2 VIDEO OUT jack
	Input from			
480i/576i (factory default setting)	COMPONENT VIDEO IN jacks		●	●
	VIDEO IN jacks		●	●
480p/576p	COMPONENT VIDEO IN jacks		●	–
	VIDEO IN jacks		●	–
720p, 1080i	COMPONENT VIDEO IN jacks		●*	–
	VIDEO IN jacks		●*	–

- : Video signals are converted and output through the video converter.
 – : Video signals are not output.

* Video signals without copyright protection are output based on the settings menu. Video signals with copyright protection are output as 480p/576p.

Playback Resolution

This function targets content via a USB device, a home network, and Internet video.

■ 480i/576i

■ 1080i

■ 480p/576p

■ 1080p

■ 720p

Output video resolution “Playback Resolution” menu setting	HDMI OUT jacks	MONITOR COMPONENT VIDEO OUT jacks	MONITOR VIDEO OUT jack	ZONE 2 COMPONENT VIDEO OUT jacks	ZONE 2 VIDEO OUT jack
480i/576i	480i/576i	480i/576i*	480i/576i*	480i/576i*	480i/576i*
480p/576p	480p/576p	480p/576p*	480i/576i*	480p/576p*	480i/576i*
720p (factory default setting)	720p	720p*	–	720p*	–
1080i	1080i	1080i*	–	1080i*	–
1080p	1080p	1080i*	–	1080i*	–

* If you play back content that is protected by Macrovision, the receiver may output the image at low resolution, or a warning message which informs that the video signals cannot be output may appear.

Notes

- If the warning message “Video cannot be output from this jack.” appears, perform the following procedure.
 - ① Select “BD/DVD” as the input for the main zone.
 - ② Set “Playback Resolution” to “480i/576i” or “480p/576p.”
- If no picture is output when you play back content via a USB device, a home network, or Internet video from the Watch/Listen menu, perform the following procedure.
 - ① Select “BD/DVD” as the input for the main zone.
 - ② Set “Playback Resolution” to a lower resolution.

3D Output Settings

This function targets content via a USB device, a home network, and Internet video.

■ Auto

Select this to display 3D compatible content in 3D.

■ Off

Select this to display all content in 2D.

TV Type

This function targets content via a USB device, a home network, and Internet video.

■ 16:9

Select this when connecting to a wide-screen TV or a TV with a wide-mode function.

■ 4:3

Select this when connecting to a 4:3 screen TV without a wide-mode function.

Screen Format

This function targets content via a USB device, a home network, and Internet video.

■ Original

Select this when connecting to a TV with a wide-mode function. Displays a 4:3 screen picture in 16:9 aspect ratio even on a wide-screen TV.

■ Fixed Aspect Ratio

Changes the picture size to fit the screen size with the original picture aspect ratio.

HDMI Settings

You can adjust the required settings for equipment connected to the HDMI jacks.

Subwoofer Level

Lets you set the level of the subwoofer to 0 dB or +10 dB when PCM signals are input via an HDMI connection. You can set the level for each input to which an HDMI input jack is assigned independently.

■ 0 dB

■ Auto

Automatically sets the level to 0 dB or +10 dB, depending on the audio stream.

■ +10 dB

Subwoofer Low Pass Filter

Lets you turn the low-pass filter for the subwoofer output on or off. The low-pass filter works when PCM signals are input via an HDMI connection. You can set the function for each input to which an HDMI input jack is assigned independently. Turn the function on if you connect a subwoofer without the crossover frequency function.

■ Off

Does not activate the low-pass filter.

■ On

Always activates the low-pass filter with a cutoff frequency of 120 Hz.

Audio Out

Lets you set the HDMI audio signals output from the playback equipment connected to the receiver via an HDMI connection.

■ TV+AMP

The sound is output from the TV speaker and the speakers connected to the receiver.

Notes

- The sound quality of the playback equipment depends on the TV's sound quality, such as the number of channels, and the sampling frequency, etc. If the TV has stereo speakers, the sound output from the receiver is also in stereo as that of the TV, even if you play multi-channel source.
- When you connect the receiver to a video equipment (projector, etc.), sound may not be output from the receiver. In this case, select "AMP."
- When you do not select an HDMI input jack as an audio input in "Audio Input Assign" in the Input Settings menu, sound is not output from the TV.

■ AMP

The HDMI audio signals from the playback equipment is only output to speakers connected to the receiver. The multi-channel sound can be played back as it is.

Note

When "Control for HDMI" is set to "On," "Audio Out" may be changed automatically.

H.A.T.S.

Lets you turn the H.A.T.S. (High quality digital Audio Transmission System) function on or off. When the H.A.T.S. function is turned on, the sound quality is enhanced because there is no jitter (timing gaps when reading signals) when transmitting digital audio signals.

■ Off

■ On

Notes

- It takes some time to output the sound after a playback operation is performed on the connected equipment (e.g., pressing the PLAY button, pressing the STOP button, pressing the PAUSE button) due to limitations of the H.A.T.S. system. The time lag depends on the sound source.

- The H.A.T.S. function of this receiver works when a Sony SCD-XA5400ES is connected to the receiver.
- While the H.A.T.S. function is working, sound is not output from the front high speakers.

Stream information about the H.A.T.S. function available

Audio signal input	Sampling frequency
Linear PCM 2ch	44.1 kHz, 48 kHz, 88.2 kHz, 96 kHz, 176.4 kHz, 192 kHz
Linear PCM Multi	44.1 kHz, 48 kHz, 88.2 kHz, 96 kHz, 176.4 kHz, 192 kHz
DSD	2.8224 MHz

Control for HDMI

Lets you turn the function which controls equipment connected to the HDMI jack using an HDMI cable on or off.

■ Off

■ On

Pass Through

Lets you output HDMI signals to the TV even when the receiver is in standby mode. For details, see "Outputting the HDMI signals even when the receiver is in standby mode (Pass Through)" (page 87).

■ Off

■ On

Video Direct

Lets you output the video input signals from the HDMI IN jack directly to the HDMI OUT jack.

■ Off

The input signals from the HDMI IN jack are output through a video processor.

■ On

The input signals from the HDMI IN jack are output directly.

Input Settings

You can adjust the settings for the connections of the receiver and other equipment.

Input Edit

Lets you set the following items for each input.

■ Watch/Listen

Sets whether an input is displayed on the Watch menu or the Listen menu.

- Watch: Displays an input to the Watch menu.
- Listen: Displays an input to the Listen menu.
- Watch/Listen: Displays an input to both the Watch and Listen menus.
- Hidden: Does not display an input to both the Watch and Listen menus. When you select an input, you can skip an input which is set to “Hidden.”

■ Icon

Sets the icon displayed on the Watch/Listen menu.

■ Name

Sets the name displayed on the Watch/Listen menu.

Note

You cannot select an input which is set to “Hidden,” or “HIDDEN” in “INPUT SKIP ?” in “INPUT SETTINGS” (page 124) without using the GUI, even if you use INPUT SELECTOR on the receiver.

Audio Input Assign

Lets you set the audio input jack(s) assigned to each input.

For details, see “Using other video/audio input jacks” (page 88).

■ HDMI

HDMI IN 1/2/3/4/5/6, none

■ Digital

OPT IN 1/2/3/4, COAX IN 1/2, none

■ Analog

Factory default setting

Video Input Assign

Lets you set the video input jack(s) assigned to each input.

For details, see “Using other video/audio input jacks” (page 88).

■ HDMI

HDMI IN 1/2/3/4/5/6, none

■ Component

COMPONENT IN 1/2, none

■ Analog

Factory default setting

Network Settings

You can adjust the settings for the network.

Internet Settings

Lets you check or change the network settings. You can change the settings for the following items either manually or automatically.

- IP Address
- DNS
- Proxy Server

Connect the receiver to the network beforehand. For details, see “5: Connecting to the network” (page 45).

Connection Server Settings

Lets you set whether or not to display the connected DLNA server.

Renderer Options

■ **Renderer Name**

Shows the renderer name of the receiver.

■ **Auto Access Permission**

Sets whether or not to allow automatic access from newly detected DLNA controller.

Renderer Access Control

Lets you set whether or not to accept commands from DLNA controllers.

External Control

Let you turn the function which controls the receiver from “ES Remote” on the home network on or off.

■ **Off**

■ **On**

Network Standby

Lets you turn the function that activates the switching hubs on the rear of the receiver and allows network controller, “ES Remote,” etc., to control the receiver on or off even when the receiver is in standby mode. In standby mode, the start-up time of the network function is reduced after the receiver is turned on.

■ **Off**

The network function turns off when the receiver is in standby mode.

■ **On**

The network function works even when the receiver is in standby mode.

Internet Services Settings

Parental Control Password

Lets you set or change the password for the parental control function. A password allows you to set a restriction on Internet video playback.

Parental Control Area Code

Playback of some Internet videos can be limited according to the geographic area. Scenes may be blocked or replaced with different scenes.

Set the function in accordance with the on-screen instructions.

Code	Area	Code	Area
2044	Argentina	2304	Korea
2047	Australia	2333	Luxembourg
2046	Austria	2363	Malaysia
2057	Belgium	2362	Mexico
2070	Brazil	2376	Netherlands

continued

Code	Area	Code	Area
2090	Chile	2390	New Zealand
2092	China	2379	Norway
2093	Colombia	2427	Pakistan
2115	Denmark	2424	Philippines
2165	Finland	2428	Poland
2174	France	2436	Portugal
2109	Germany	2489	Russia
2200	Greece	2501	Singapore
2219	Hong Kong	2149	Spain
2248	India	2499	Sweden
2238	Indonesia	2086	Switzerland
2239	Ireland	2543	Taiwan
2254	Italy	2528	Thailand
2276	Japan	2184	United Kingdom

Internet Video Parental Control

Playback of some Internet videos can be limited according to the age of the users. Scenes may be blocked or replaced with different scenes.

Set the function in accordance with the on-screen instructions.

Internet Video Unrated

Lets you set whether or not access to allow playback of unrated Internet videos.

■ Allow

Allows the playback of unrated Internet videos.

■ Block

Blocks the playback of unrated Internet videos.

Zone Settings

You can adjust settings for the main zone, zone 2 or zone 3.

Zone Control

To turn the power on or off for zone 2/zone 3

You can turn zone 2 or zone 3 operation on or off.

- 1 Select the zone you want to turn on or off, then press .
- 2 Select "On" or "Off," then press .
 - On
 - Off

To select the output source for each zone

You can select the source that is output to the zone. Audio and video signals are output to zone 2, while only audio signals are output to zone 3.

- 1 Select the zone to which you want to output video/audio signals, then press .
- 2 Select "Input," then press .
- 3 Select the input, then press .

To adjust the volume for zone 2

If the SURROUND BACK (ZONE 2) terminals are used with a zone 2 connection, you can also adjust the volume of zone 2. If you set "Line Out" to "Variable," you can also adjust the volume using "Zone Control." If you want to adjust the volume of zone 2 in zone 2 using the remote control, see "Operating the receiver from another zone (ZONE 2/ZONE 3 operations)" (page 82).

- 1 Select the zone for which you want to adjust the volume, then press .

- 2 Select “Volume,” then press \oplus .
- 3 Adjust the volume, then press \oplus .

Zone Setup

To preset the volume for main zone/zone 2

You can preset the volume of turning the power on for each zone.

- 1 Select the zone for which you want to preset the volume, then press \oplus .
- 2 Select “Preset Volume,” then press \oplus .
- 3 Adjust the volume, then press \oplus .

During the adjustment, the sound is output at the volume level to which you have adjusted it, regardless of the value of MASTER VOLUME control.

If you select “Off,” each zone is activated at the same volume as that in effect when you turned the power off last time.

Note

- You cannot preset the volume in the following cases.
 - The SURROUND BACK (ZONE 2) terminals are used for the surround back speakers or the front high speakers, or are used with a bi-amplifier connection.
 - “Line Out” is set to “Fixed.”

Line Out

You can set the volume control for the ZONE 2 AUDIO OUT jacks to “Variable” or “Fixed.” For details, see “Set the volume control for zone 2” (page 81)

■ Fixed

■ Variable

12V Trigger

Lets you select various options for use of the 12V Trigger function.

■ Off

Lets you turn off output of 12V triggers even when the main receiver is turned on.

■ Ctrl

Lets you turn the output of 12V triggers on or off manually using the control command of an external control device.

■ Zone

Lets you turn the output of 12V triggers on or off based on whether the selected zone is turned on or off.

■ Input (for “Main” only)

Lets you turn on the output of 12V triggers when the preset input is selected. When you select “Input,” the setting display which sets each input trigger to on/off appears. Press $\blacktriangle/\blacktriangledown$ to select the input, then press \oplus to check the box.

■ HDMI A (for “Main” only)

Lets you turn the output of 12V triggers on or off based on the output setting of the HDMI OUT A jack.

■ HDMI B (for “Main” only)

Lets you turn the output of 12V triggers on or off based on the output setting of the HDMI OUT B jack.

■ Main (for “Zone2” and “Zone3” only)

Lets you link operation of trigger in zone 2 or zone 3 to the TRIGGER OUT MAIN jack.

System Settings

You can customize the settings of the receiver.

Language

Lets you select the language for the messages on the screen.

- English
- Español
- Français
- Deutsch

Auto Standby

Lets you turn the function that switches the main zone to standby mode automatically if you do not operate the receiver for a specific period of time or when there is no signal input to the receiver on or off.

■ Off

Does not switch to standby mode.

■ On

Switches to standby mode after approximately 30 minutes.

Note

- This function does not work in the following cases.
 - “MULTI IN,” “FM/AM,” or “SIRIUS” is selected.
 - When you play back via a USB device, an iPhone/iPod, a home network, or Internet video.

Settings Lock

Lets you lock the settings of the receiver.

■ On

You can only turn this function on using the setting menu. When you turn this function off, perform the following procedure.

SPEAKERS (A/B/A+B/OFF)

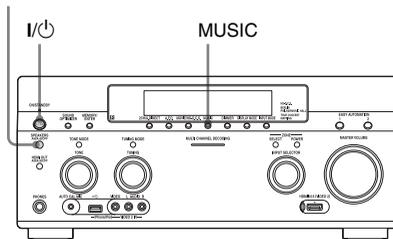

- 1 Press I/⏻ to turn off the receiver.
- 2 While holding down MUSIC and SPEAKERS (A/B/A+B/OFF), press I/⏻ to turn on the receiver.

RS232C Control

Let you turn the control mode for maintenance and service on or off.

■ Off

■ On

Software Update Notification

Lets you set whether or not to inform you of newer software version information on the TV screen.

■ On

■ Off

To update the receiver

See “Network Update” (page 119) to update the software of the receiver.

Note

- In the following cases, a message appears on the TV screen and the update of the receiver is not performed.
 - When all versions are the latest one.

- When the receiver cannot retrieve the data, such as when the network has not been set up, or when the server is down, etc.

Initialize Personal Information

Lets you erase personal information related to Internet video, such as the Internet content list, “Favorites List,” etc.

System Information

Displays the software version of the receiver.

EULA

Displays the EULA screen on the TV screen.

Network Update

You can update and improve the functions of the receiver.

For information about update functions, refer to the following website:

<http://www.sony.com/essupport>

The GUI and display window of the receiver are turned off, and the MULTI CHANNEL DECODING lamp on the front panel flashes during the update.

When the update completes, the receiver will restart automatically.

It may take about 50 minutes for the update to complete. The time required for the update to complete varies, depending on the speed of the Internet connection.

Note

Do not turn the receiver off or disconnect the network cable during software updating. It may cause a malfunction.

Operating without using the GUI

You can operate the receiver using the display window of the receiver even if the TV is not connected to the receiver.

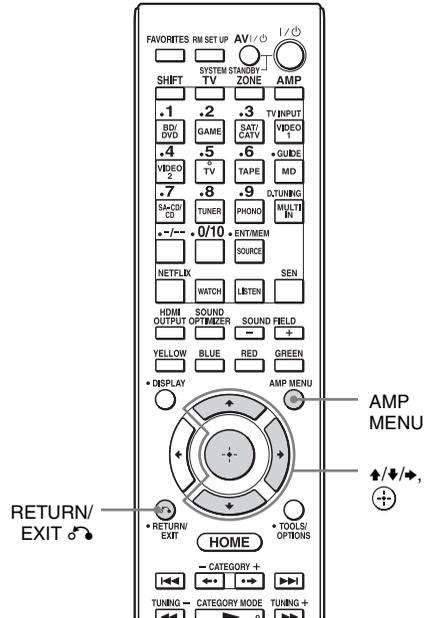

Using the menu in the display window

- 1 Turn on the receiver.
- 2 Press AMP MENU.

The menu is displayed in the display window of the receiver.

Example: When you select “SPEAKER SETTINGS.”



3 Press \uparrow/\downarrow repeatedly to select the menu, then press \oplus .

4 Press \uparrow/\downarrow repeatedly to select the menu item, then press \oplus .

The parameter appears in brackets.



5 Press \uparrow/\downarrow repeatedly to select the parameter you want, then press \oplus .

The parameter is entered and the brackets disappear from the display.



To return to the previous step

Press RETURN/EXIT \circlearrowright .

Menu list (in the display window)

The following options are available in each menu.

“■■■■...” in the table signifies the parameter for each item.

Menu	Item	Parameter
AUTO CALIBRATION	AUTO CAL START ?	
	FRONT B CONNECT:■■■■?	YES, NO
	5 4 3 2 1	
	MEASURING: TONE	
	MEASURING: T.S.P.	
	MEASURING: WOOFER	
	COMPLETE [■■■■■■■■■■■■■■■■■■■■]	RETRY, SAVE EXIT, WRN CHECK, PHASE INFO, DIST. INFO, LEVEL INFO, EXIT
	WARNING CODE [■■■■:4■]	FL, FR, C, SL, SR, SBR, SBL, SW, LH, RH : 0, 1, 2, 3, 4
	NO WARNING	
	PHASE.INFO [■■■■:■■■■]	FL, FR, C, SL, SR, SBR, SBL, SW, LH, RH :OUT, IN
	DIST.INFO [■■■■■■■■■■■■■■■■■■■■]	FL, FR, C, SL, SR, SBR, SBL, SW, LH, RH
	LEV.INFO [■■■■:■■■■■■■■■■■■■■■■■■■■]dB	FL, FR, C, SL, SR, SBR, SBL, SW, LH, RH
	ERROR CODE [■■■■:3■]	F, SR, SB : 0, 1, 2, 3, 4
	RETRY? [■■■■■■]	YES, EXIT
	CANCEL	
	CAL TYPE [■■■■■■■■■■■■■■■■■■■■]	FULL FLAT, ENGINEER, FRONT REF, USER REF, OFF
	A.P.M. [■■■■■■]	AUTO, OFF
	SP RELOCATION [■■■■■■■■]	TypeA, TypeB, OFF
	FRONT REF TYPE [■■■■]	L/R, L, R
	SP PAIR MATCH [■■■■]	ALL, SUR, OFF
POSITION [■■■■■■■■■■■■■■■■■■■■]	POS.1, POS.2, POS.3	
NAME IN ? [■■■■■■■■■■■■■■■■■■■■]		

Menu	Item	Parameter
LEVEL SETTINGS	TEST TONE [■■■■■■■■■■]	OFF, L to RH (AUTO), L to RH (FIX)
	PHASE NOISE [■■■■■■■■■■]	OFF, L/R, L/C, C/R, R/SR, SR/SBR, SR/SB, SBR/SBL, SR/SL, SB/SL, SBL/SL, SL/L, LH/RH, L/SR, SL/R, L/RH, LH/R
	PHASE AUDIO [■■■■■■■■■■]	OFF, L/R, L/C, C/R, R/SR, SR/SBR, SR/SB, SBR/SBL, SR/SL, SB/SL, SBL/SL, SL/L, LH/RH, L/SR, SL/R, L/RH, LH/R
	FRONT L [■■■.■dB]	-10.0 dB to +10.0 dB (0.5 dB interval)
	FRONT R [■■■.■dB]	-10.0 dB to +10.0 dB (0.5 dB interval)
	CENTER [■■■.■dB]	-20.0 dB to +10.0 dB (0.5 dB interval)
	SURROUND L [■■■.■dB]	-20.0 dB to +10.0 dB (0.5 dB interval)
	SURROUND R [■■■.■dB]	-20.0 dB to +10.0 dB (0.5 dB interval)
	SUR BACK [■■■.■dB]	-20.0 dB to +10.0 dB (0.5 dB interval)
	SUR BACK L [■■■.■dB]	-20.0 dB to +10.0 dB (0.5 dB interval)
	SUR BACK R [■■■.■dB]	-20.0 dB to +10.0 dB (0.5 dB interval)
	LEFT HIGH [■■■.■dB]	-20.0 dB to +10.0 dB (0.5 dB interval)
	RIGHT HIGH [■■■.■dB]	-20.0 dB to +10.0 dB (0.5 dB interval)
	SUBWOOFER [■■■.■dB]	-20.0 dB to +10.0 dB (0.5 dB interval)
	ALL SUR LEVEL [■■■.■dB]	-5 dB to +5 dB (1 dB interval)

Menu	Item	Parameter
SPEAKER SETTINGS	SP PATTERN [■■■■■]	5/4.1 to 2/0 (28 patterns)
	SB OUTPUT [■■■■■■■■]	SPEAKER, PREOUT
	FH OUTPUT [■■■■■■■■]	SPEAKER, PREOUT
	FRONT SIZE [■■■■■]	LARGE, SMALL
	CENTER SIZE [■■■■■]	LARGE, SMALL
	SURROUND SIZE [■■■■■]	LARGE, SMALL
	FH SIZE [■■■■■]	LARGE, SMALL
	SB ASSIGN [■■■■■]	OFF, BI-AMP, ZONE2
	FRONT L [■■■■■■■■■■]	
	FRONT R [■■■■■■■■■■]	
	CENTER [■■■■■■■■■■]	
	SURROUND L [■■■■■■■■■■]	
	SURROUND R [■■■■■■■■■■]	
	SUR BACK [■■■■■■■■■■]	1.0 to 10.0 (m) (1 cm interval) 3' 3" to 32' 9" (1 inch interval)
	SUR BACK L [■■■■■■■■■■]	
	SUR BACK R [■■■■■■■■■■]	
	LEFT HIGH [■■■■■■■■■■]	
	RIGHT HIGH [■■■■■■■■■■]	
	SUBWOOFER [■■■■■■■■■■]	
	DISTANCE UNIT [■■■■■]	meter, feet
	FR CROSSOVER [■■■■■]	40 to 200 (10 Hz interval)
	CNT CROSSOVER [■■■■■]	40 to 200 (10 Hz interval)
	SUR CROSSOVER [■■■■■]	40 to 200 (10 Hz interval)
	FH CROSSOVER [■■■■■]	40 to 200 (10 Hz interval)
	CNT A.DOWN MIX [■■■■]	OFF, ON
	SP IMPEDANCE [■ohm]	8 ohm, 4 ohm

Menu	Item	Parameter
TUNER SETTINGS	FM MODE [■■■■■■■]	STEREO, MONO
	NAME IN ? [■■■■■■■■■]	
	FM■■ [■■■■■■■■■]	
	NAME IN ? [■■■■■■■■■]	
	AM■■ [■■■■■■■■■]	
	PARENTAL LOCK [■■■]	YES, NO
	LOCK CODE EDIT	
	SR ANTENNA AIMING	
	SIRIUS ID DISPLAY	
AUDIO SETTINGS	D.L.L. [■■■■■]	AUTO2, AUTO1, OFF
	SOUND OPTIMIZER [■■■]	ON, OFF
	AUTO VOLUME [■■■]	ON, OFF
	S.WOOFER MUTING [■■■]	ON, OFF
	A/V SYNC [■■■■■■■■■■■]	HDMI AUTO, 0 ms to 1200 ms (10 ms interval)
	DUAL MONO [■■■■■■■■■]	MAIN/SUB, MAIN, SUB
	DEC. PRIORITY [■■■■■]	AUTO, PCM
	D. RANGE COMP. [■■■]	OFF, AUTO, ON
VIDEO SETTINGS	RESOLUTION [■■■■■■■■■■■]	DIRECT, AUTO, 480/576i, 480/576p, 720p, 1080i, 1080p
	ZONE RESO. [■■■■■■■■■■■]	480/576i, 480/576p, 720p, 1080i
HDMI SETTINGS	CTRL FOR HDMI [■■■]	ON, OFF
	PASS THROUGH [■■■■■]	ON, OFF
	H.A.T.S. [■■■]	ON, OFF
	AUDIO OUT [■■■■■■■■■]	AMP, TV+AMP
	SW LEVEL [■■■dB]	AUTO, +10 dB, 0 dB
	SW LPF [■■■]	ON, OFF
	VIDEO DIRECT [■■■]	ON, OFF
SYSTEM SETTINGS	RS232C CONTROL [■■■]	ON, OFF
	NETWORK STANDBY [■■■]	ON, OFF
	AUTO STANDBY [■■■]	ON, OFF
	VERSION [■.■■■■]	-

To change the display

The display panel provides various information of the receiver status such as sound field.

- 1 Select the input for which you want to check the information.
- 2 Press DISPLAY MODE on the receiver repeatedly.

Each time you press DISPLAY MODE, the display will change as follows.

Input you selected → Sound field type → Stream information* → Input name you entered ...

* Stream information may not be displayed.

When listening to FM and AM radio

Station name → Frequency → Sound field type ...

Index name appears only when you have assigned one to the input or preset station.

Index name does not appear when only blank spaces have been entered.

When tuning in a channel from the Sirius satellite radio

Channel name → Channel number → Category → Artist name → Song title → Composer name → Signal strength → Sound field type

Using the Remote Control

Operating each equipment using the remote control

You can control Sony or non-Sony equipment you are using with the remote control supplied with the receiver.

The remote control is initially set to control Sony equipment.

When you change the settings of the remote control according to the equipment you are using, you can control non-Sony and other Sony equipment that the remote control is initially unable control (page 128).

Operating the equipment connected to the receiver

- 1 Press the input button that matches the connected equipment that you want to operate.
- 2 Press the appropriated buttons to use the function listed in the table below.

Note

You may not be able to operate some functions for the equipment you are using.

Table of buttons used to control each equipment

Equipment	TV	VCR	DVD player, DVD/VCR combo	Blu-ray Disc Player	HDD Recorder	PSX	Video CD player, LD player	Digital CATV terminal	DSS	Tape deck A/B	DAT deck	CD player, MD deck
AV I/⏪	●	●	●	●	●	●	●	●	●		●	●
Numeric buttons	●	●	●	●	●	●	●	●	●	●	●	●
TV INPUT	●											
GUIDE	●		● ^{c)}	●	●	●		●				
-/--	●	●	●	●	●	●	●	●	●	●		●
ENT/MEM	●	●	●	●	●	●	● ^{a)}	●	●	●	●	●
Color buttons	●		● ^{c)}	●	●							
TOOLS/OPTIONS	●		●	●	●	●		●	●			
DISPLAY	●	●	●	●	●	●	●	●	●			●
RETURN/EXIT	●		●	●	●	●	●	●	●			
⏪/⏩/⏮/⏭, HOME	●	●	●	●	●	●		●	●			
⏮/⏭/⏪/⏩	●	●	●	●	●	●	●	●		● ^{b)}	●	●
⏮/⏭	●		●	●	●	●		●				
⏮/TUNING -, ⏭/TUNING +	●	●	●	●	●	●	●	●		●	●	●
DISC SKIP			● ^{c)}	●			● ^{d)}					●
▶, II, ■	●	●	●	●	●	●	●	●		●	●	●
MUTING, TV VOL +/-	●											
PRESET +/-, TV CH +/-	●	●	●	●	●		● ^{a)}	●	●			

continued

Equipment	TV	VCR	DVD player, DVD/VCR combo	Blu-ray Disc Player	HDD Recorder	PSX	Video CD player, LD player	Digital CATV terminal	DSS	Tape deck A/B	DAT deck	CD player, MD deck
Button												
TOP MENU, POP UP/MENU			●	●			●					
AUDIO	●	●	●	●	●	●			●			
SUBTITLE	●		●	●	●	●						

- a) LD player only
- b) Deck B only
- c) DVD only
- d) Video CD only

Turning off all connected equipment (SYSTEM STANDBY)

Even when this receiver is standby mode, zone 2 or zone 3 remain turned on. To turn off all Sony equipment, including connections to each zone, press **I/⏻** and **AV I/⏻** on the remote control at the same time.

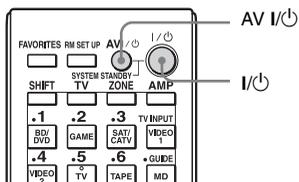

Programming the remote control

You can customize the remote control to match the equipment connected to your receiver. You can even program the remote control to operate non-Sony equipment and also Sony equipment that the remote control is normally unable to operate.

The procedure below uses as an example a case in which a VCR made by a company other than Sony is connected to the VIDEO 1 IN jacks on the receiver.

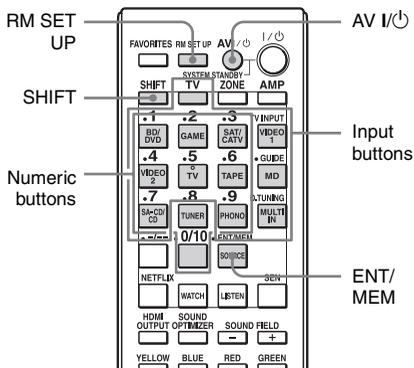

1 Press **AV I/⏻** while pressing **RM SET UP**.

The RM SET UP button flashes.

2 While the RM SET UP button is flashing, press the input button (including the TV button) of the equipment you want to control.

For example, if you are going to control a VCR connected to VIDEO 1 IN jack, press VIDEO 1.

RM SET UP and SHIFT light up, and the input button flashes.

If you press the button for an equipment of which you cannot program the remote control, such as TUNER, PHONO, or SOURCE, etc., the RM SET UP button keeps flashing.

3 Press the numeric buttons to enter the numeric code.

The input button lights up.

If more than one code exists, trying entering the first one which corresponds to the equipment.

Note

Only the codes in the 500's are valid for the TV button.

4 Press ENT/MEM.

Once the numeric code has been verified, the RM SET UP button flashes twice and the remote control automatically exits the programming mode. The input button also turns off.

To cancel programming

Press RM SET UP during any step.

The numeric codes corresponding to the equipment and the maker of the equipment

Use the numeric codes in the tables below to program non-Sony equipment and also Sony equipment that the remote control is initially unable to operate. Since the signal from the remote control received by the equipment differs by its model and the year, more than one numeric code may be assigned to an equipment. If you fail to program your remote control using one of the codes, try using other codes.

Notes

- The numeric codes are based on the latest information available for each brand. There is a chance, however, that your equipment will not respond to some or all of the codes.
- All of the input buttons on this remote control may not be available when used with your particular equipment.

To control a CD player

Maker	Code(s)
SONY	101, 102, 103
DENON	104, 123
JVC	105, 106, 107
KENWOOD	108, 109, 110
MAGNAVOX	111, 116
MARANTZ	116
ONKYO	112, 113, 114
PANASONIC	115
PHILIPS	116
PIONEER	117
TECHNICS	115, 118, 119
YAMAHA	120, 121, 122

To control a DAT deck

Maker	Code(s)
SONY	203
PIONEER	219

To control a tape deck

Maker	Code(s)
SONY	201, 202

continued

Maker	Code(s)
DENON	204, 205
KENWOOD	206, 207, 208, 209
NAKAMICHI	210
PANASONIC	216
PHILIPS	211, 212
PIONEER	213, 214
TECHNICS	215, 216
YAMAHA	217, 218

To control an MD deck

Maker	Code(s)
SONY	301
DENON	302
JVC	303
KENWOOD	304

To control an HDD recorder

Maker	Code(s)
SONY	307, 308, 309

To control a Blu-ray Disc Player

Maker	Code(s)
SONY	310, 311, 312
LG	337
PANASONIC	335
SAMSUNG	336

To control a PSX

Maker	Code(s)
SONY	313, 314, 315

To control a DVD player

Maker	Code(s)
SONY	401, 402, 403
BROKSONIC	424
DENON	405
HITACHI	416
JVC	415, 423
MITSUBISHI	419
ORITRON	417
PANASONIC	406, 408, 425
PHILIPS	407
PIONEER	409, 410
RCA	414
SAMSUNG	416, 422

Maker	Code(s)
TOSHIBA	404, 421
ZENITH	418, 420

To control a DVD/VCR COMBO (recorder)

Maker	Code(s)
SONY	411

To control a HDD/DVD COMBO (recorder)

Maker	Code(s)
SONY	401, 402, 403

To control a TV

Maker	Code(s)
SONY	501
AIWA	501, 536, 539
AKAI	503
AOC	503
CENTURION	566
CORONADO	517
CURTIS-MATHES	503, 551, 566, 567
DAYTRON	517, 566
DAEWOO	504, 505, 506, 507, 515, 544
FISHER	508, 545
FUNAI	548
FUJITSU	528
GOLDSTAR/LG	503, 512, 515, 517, 534, 544, 556, 568, 576
GRUNDIG	511, 533, 534
HITACHI	503, 513, 514, 515, 517, 519, 544, 557, 571
ITT/NOKIA	521, 522
J.C.PENNY	503, 510, 566
JVC	516, 552
KMC	517
MAGNAVOX	503, 515, 517, 518, 544, 566
MARANTZ	527
MITSUBISHI/MGA	503, 519, 527, 544, 566, 568
NEC	503, 517, 520, 540, 544, 554, 566
NORDMENDE	530, 558
NOKIA	521, 522, 573, 575
PANASONIC	509, 524, 553, 559, 572
PHILIPS	515, 518, 557, 570, 571
PHILCO	503, 504, 514, 517, 518

Maker	Code(s)
PIONEER	509, 525, 526, 540, 551, 555
PORTLAND	503
QUASAR	509, 535
RADIO SHACK	503, 510, 527, 565, 567
RCA/PROSCAN	503, 510, 523, 529, 544
SAMSUNG	503, 515, 517, 531, 532, 534, 544, 556, 557, 562, 563, 566, 569
SAMPO	566
SABA	530, 537, 547, 549, 558
SANYO	508, 545, 546, 560, 567
SCOTT	503, 566
SEARS	503, 508, 510, 517, 518, 551
SHARP	517, 535, 550, 561, 565
SYLVANIA	503, 518, 566
THOMSON	530, 537, 547, 549
TOSHIBA	535, 539, 540, 541, 551
TELEFUNKEN	530, 537, 538, 547, 549, 558
TEKNIKA	517, 518, 567
WARDS	503, 517, 566
YORK	566
ZENITH	542, 543, 567
GE	503, 509, 510, 544
LOEWE	515, 534, 556

To control an LD player

Maker	Code(s)
SONY	601, 602, 603
PIONEER	606

To control a video CD player

Maker	Code(s)
SONY	605

To control a VCR

Maker	Code(s)
SONY	701, 702, 703, 704, 705, 706
AIWA*	710, 750, 757, 758
AKAI	707, 708, 709, 759
BLAUPUNKT	740
EMERSON	711, 712, 713, 714, 715, 716, 750
FISHER	717, 718, 719, 720
GENERAL ELECTRIC (GE)	721, 722, 730

Maker	Code(s)
GOLDSTAR/LG	723, 753
GRUNDIG	724
HITACHI	722, 725, 729, 741
ITT/NOKIA	717
JVC	726, 727, 728, 736
MAGNAVOX	730, 731, 738
MITSUBISHI/MGA	732, 733, 734, 735
NEC	736
PANASONIC	729, 730, 737, 738, 739, 740
PHILIPS	729, 730, 731
PIONEER	729
RCA/PROSCAN	722, 729, 730, 731, 741, 747
SAMSUNG	742, 743, 744, 745
SANYO	717, 720, 746
SHARP	748, 749
TELEFUNKEN	751, 752
TOSHIBA	747, 756
ZENITH	754

* If an AIWA VCR does not work even though you enter the code for AIWA, enter the code for Sony instead.

To control a satellite tuner (box)

Maker	Code(s)
SONY	801, 802, 803, 804, 824, 825, 865
AMSTRAD	845, 846
BskyB	862
GENERAL ELECTRIC(GE)	866
GRUNDIG	859, 860
HUMAX	846, 847
THOMSON	857, 861, 864, 876
PACE	848, 849, 850, 852, 862, 863, 864
PANASONIC	818, 855
PHILIPS	856, 857, 858, 859, 860, 864, 874
NOKIA	851, 853, 854, 864
RCA/PROSCAN	866, 871
HITACHI/BITA	868
HUGHES	867
JVC/Echostar/Dish Network	873
MITSUBISHI	872
SAMSUNG	875
TOSHIBA	869, 870

continued

To control a cable box

Maker	Code(s)
SONY	821, 822, 823
HAMLIN/REGAL	836, 837, 838, 839, 840
JERROLD/G.I./MOTOROLA	806, 807, 808, 809, 810, 811, 812, 813, 814, 819
JERROLD	830, 831
OAK	841, 842, 843
PANASONIC	816, 826, 832, 833, 834, 835
PHILIPS	830, 831
PIONEER	828, 829
RCA	805
SCIENTIFIC ATLANTA	815, 816, 817
TOCOM/PHILIPS	830, 831
ZENITH	826, 827

Performing several commands in sequence automatically (Macro Play)

The Macro Play function lets you link several commands in a sequential order as a single command.

The remote control provides 2 macro lists (MACRO 1 and MACRO 2). You can specify up to 20 commands for each macro list.

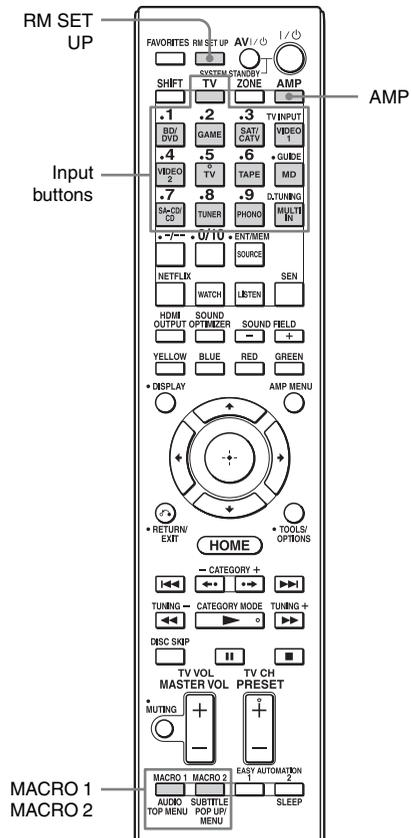

Program the sequence of the operation

1 Press MACRO 1 or MACRO 2 for more than 1 second while pressing RM SET UP.

The RM SET UP button flashes and one of the input buttons lights up (as the factory default setting, the BD/DVD button lights).

2 Press the input button for the equipment for which you want to program the sequence of operation(s).

3 Press the buttons you want to program in the same sequence as you want the operation(s) to be performed.

You can program particular operations using the following buttons.

Press	Operations to be programmed
The input button for more than 1 second	Switches inputs.
MACRO 1 or MACRO 2	Make a one second interval. When you want to make a longer interval, press MACRO 1 or MACRO 2 repeatedly.

The input button selected in step 2 flashes twice, then lights up again.

4 Repeat steps 2 and 3 when you want to program operations for other equipment.

5 Press RM SET UP to finish the programming process.

To cancel programming

Not pressing any button for 60 seconds cancels the settings.

The previous command remains valid.

Starting macro play

1 Press AMP.

The AMP button lights up, and then turns off.

2 Press MACRO 1 or MACRO 2 to start the macro.

The macro starts and execute the commands in the order you assigned them. While the commands are being sent, the AMP button flashes and the RM SET UP button lights up. When the commands have been sent, the RM SET UP and AMP buttons turn off.

To erase a programmed macro

1 Press MACRO 1 or MACRO 2 for more than 1 second while pressing RM SET UP to clear the stored macro.

The RM SET UP button flashes.

2 Press RM SET UP.

Settings stored as macro are cleared.

Setting remote control codes that are not stored in the remote control

Even if a remote control code is not one of the presets stored in the remote control, it is possible for the remote control to learn the code using the learning function.

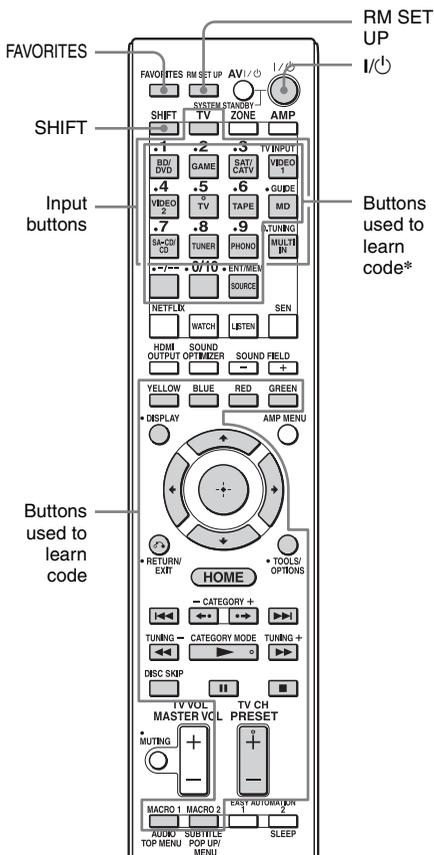

* To store a new command on one of those buttons, press SHIFT beforehand.

1 Press FAVORITES while pressing RM SET UP.

The RM SET UP button lights up. When the memory capacity for storing remote control codes reaches a certain limit, the RM SET UP button flashes 10 times, and then the learning process is finished.

2 Press the input button (including the TV button) for the equipment you want to operate with the new command.

The input button flashes. (The RM SET UP button remains lit.)

Even if you press an input button on which you cannot store a new command such as SOURCE, etc., the input button will not flash.

3 Press the button on which you want to store the new command. For the buttons with an asterisk in the illustration above, press SHIFT, then press the button.

The input button you selected in step 2 lights up. (The RM SET UP button remains lit.)

When the learning process fails, the RM SET UP button flashes five times.

If you fail to store the new command, make sure that a command has not already been stored on the button on which you want to store the new command.

If you want to store the new command on the button on which you have already stored the command, erase the stored command beforehand.

4 Point the remote control code receiver section of the remote control toward the transmitter on the remote control to be learned from.

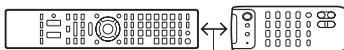

About 5 cm - 10 cm (2" - 4")

5 Press the button on the remote control to be learned from to transmit the remote control code.

While the remote control of the receiver is receiving the signal, the input button selected in step 2 turns off. The RM SET UP button flashes twice, then the learning process is completed. When the learning process fails, the RM SET UP button flashes five times. Try to perform process again from step 2.

6 Press RM SET UP to finish the learning function process.

To cancel learning

Press RM SET UP. Also, not pressing any button for 60 seconds cancels the settings. However, after performing step 3, you cannot cancel the settings even if you press RM SET UP. In this case, after leaving the remote control untouched for 10 seconds, press RM SET UP to cancel the settings.

Using a command that has been learned

When selecting a learned input, press the button used to learn that function.

To erase the learned code

- 1 Press FAVORITES while pressing RM SET UP.
- 2 Press the input button for which you want to clear the setting. The input button flashes. (The RM SET UP button remains lit.)
- 3 Press I/⏻ for more than 1 second. The input button flashes twice, repeatedly.
- 4 Press the button which learned the command to clear the stored setting.

The RM SET UP button flashes twice, then the clearing process is completed. When the clearing process fails, the RM SET UP button flashes five times. Try to perform process again from step 2.

- 5 Press RM SET UP to finish the erasing process.

Clearing the memory of the multifunction remote control

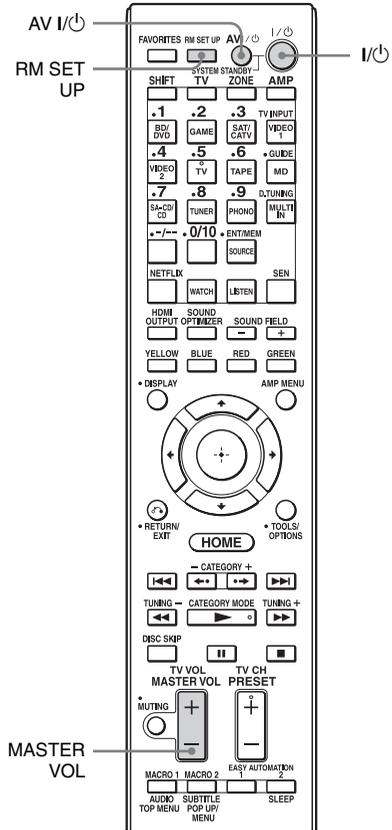

1 Hold down I/⏻ while pressing MASTER VOL –, then press AV I/⏻, all at the same time.

The RM SET UP button flashes three times.

2 Release all buttons.

All the contents of the remote control's memory (e.g., all the programmed data) are cleared.

Precautions

On safety

Should any solid object or liquid fall into the cabinet, unplug the receiver and have it checked by qualified personnel before operating it any further.

On power sources

- Before operating the receiver, check that the operating voltage is identical with your local power supply.
The operating voltage is indicated on the nameplate on the back of the receiver.
- If you are not going to use the receiver for a long time, be sure to disconnect the receiver from the wall outlet. To disconnect the AC power cord (mains lead), grasp the plug itself; never pull the cord.
- One blade of the plug is wider than the other for the purpose of safety and will fit into the wall outlet only one way. If you are unable to insert the plug fully into the outlet, contact your dealer.
- AC power cord (mains lead) must be changed only at a qualified service shop.

On heat buildup

Although the receiver heats up during operation, this is not a malfunction. If you continuously use this receiver at a large volume, the cabinet temperature of the top, side and bottom rises considerably*. To avoid burning yourself, do not touch the cabinet.

* The top of the cabinet may become too hot to touch.

On placement

- Place the receiver in a location with adequate ventilation to prevent heat buildup and prolong the life of the receiver.

- Do not place the receiver near heat sources, or in a place subject to direct sunlight, excessive dust, or mechanical shock.
- Do not place anything on top of the cabinet that might block the ventilation holes and cause malfunctions.

On cleaning

Clean the cabinet, panel, and controls with a soft cloth slightly moistened with a mild detergent solution. Do not use any type of abrasive pad, scouring powder, or solvent, such as alcohol or benzine.

If you have any questions or problems concerning your receiver, please consult your nearest Sony dealer.

Troubleshooting

If you experience any of the following difficulties while using the receiver, use this troubleshooting guide to help you remedy the problem. Should any problem persist, consult your nearest Sony dealer.

General

The receiver is turned off automatically.

- “Auto Standby” is set to “On” (page 118).
- The sleep timer function is working (page 94).
- “PROTECTOR” is working (page 147).

The receiver is turned on automatically.

- “Control for HDMI” is set to “On” or “Pass Through” is set to “Off.” In this case, the receiver may be turned on by operating other equipment connected to it.

No picture and no sound are output, or the picture and sound are corrupted.

- The receiver is placed near equipment such as a television, VCR, or tape deck. If the receiver is being used in combination with a television, VCR, or tape deck, and is placed too close to that equipment, noise may result, and picture quality may suffer. This is especially likely when using an indoor antenna (aerial). Therefore, we recommend using an outdoor antenna (aerial).

The top of the receiver is hot.

- Phenomenon is specific to this amplifier. This is not a malfunction. If “Control for HDMI,” “Pass Through,” or “Network Standby” is set to “On,” or the power for zone 2 or zone 3 is turned on, the top of the receiver may become hot even while the receiver is in standby mode. This condition occurs because current is

flowing in the internal circuits of the receiver, and this is normal.

Video

There is no picture or an unclear picture appears on the TV screen or monitor, regardless of type of picture.

- Select the appropriate input on the receiver (page 54).
- Set your TV to the appropriate input mode.
- Move your TV away from the audio equipment.
- Assign the component video input correctly (page 88).
- The input signal should be same as input when you are up-converting an input signal with this receiver (page 22).
- Make sure that cables are correctly and securely connected to equipment.
- Depending on the playback equipment, equipment may need to be set up. Refer to the operating instructions supplied with the each equipment.

Images appear later than the associated sound is played.

- Depending on the equipment connected to the HDMI jack, or the source played back, images may appear later than the associated sound. In this case, change the setting of “A/V Sync” in the Audio Settings menu (page 108).

Recording cannot be carried out.

- Check that the equipment are connected correctly (page 30).
- Select the source equipment (page 54).
- Check the connection of the recording deck according to the video signals you want to record. Analog input signals (composite video) can be output only from the analog output jacks.
- Video input signals via the HDMI IN jacks cannot be recorded.
- Copyright protection to prevent recording is contained in the sources. In this case,

you may not be able to record from the sources.

- Set “Auto Standby” to “Off” (page 118). While only composite video signals are being recorded, the auto standby function of the receiver may start up and interrupt the recording.

Specific type of image is not output or corrupted.

Component video output

- The resolution of output signals from the COMPONENT VIDEO OUT jacks may not be supported by your TV. In this case, select the appropriate resolution on the receiver (page 109).
- COMPONENT VIDEO MONITOR OUT jacks have restrictions on resolution when the resolution of video signals protected by copyright technology is converted. The resolution of the signals output to the COMPONENT VIDEO MONITOR OUT jacks is converted up to 480p/576p.

HDMI output

- The output of the HDMI video signals of the receiver may be set to “OFF.” In this case, select “HDMI A” or “HDMI B” using the HDMI OUTPUT button (page 86).
- If the compatible video format differs between the monitors connected to the HDMI OUT A jack and the HDMI OUT B jack of the receiver, “HDMI A + B” may not work. In this case, select “HDMI A” or “HDMI B” using the HDMI OUTPUT button (page 86).
- Depending on the playback equipment you connect, “HDMI A + B” may not work. If the image is not output due to settings on the playback equipment, set the output setting on the playback equipment to auto.
- Be sure to use a connecting cable for the HDMI jack corresponding to High Speed HDMI cable when you view images or listen to sound, especially for the 1080p, Deep Color, or 3D transmission.

- Set “Video Direct” to “On” in the HDMI Settings menu in the following cases.
 - Images from the equipment connected to the HDMI jack may be distorted.
 - Images or sound from the equipment connected to the HDMI jack may be interrupted when video signals are switched.
 - The start of the video is not output when the 3D video is switched, or the colors of the 3D video are improper.

3D image

- Depending on the TV or the video equipment, 3D images may not be displayed. Check the 3D image formats supported by the receiver (page 150).

VCR

- If you use a VCR without an image improvement circuit, such as TBC, the images may be distorted.

Adobe_{RGB} or Adobe_{YCC601}

- Set “Video Direct” to “On” to receive Adobe_{RGB} or Adobe_{YCC601} signals.

When you select “My Video,” “My Music,” “My Photo,” “Internet Video,” “Internet Music,” “Internet Photo,” “Internet Network,” or “Sony Entertainment Network” from the Watch/Listen menu, no picture is output.

- Select “BD/DVD” using INPUT SELECTOR on the receiver once, then set “Playback Resolution” to “480p/576p” in the Video Settings menu using the GUI (page 111), and select the content again.

The Pass Through function does not work.

- “HDMI B” is selected. Select “HDMI A” or “HDMI A + B” using the HDMI OUTPUT button.

Audio

There is no sound, no matter which equipment is selected, or only a very low-level sound is heard.

- Check that the speakers and equipment are connected correctly.
- Check that both the receiver and all equipment are turned on.
- Check that MASTER VOLUME control is not set at $-\infty$ dB. Try to set it at about -40 dB.
- Check that SPEAKERS (A/B/A+B/OFF) is set to OFF (page 10).
- Press MUTING on the remote control to cancel the muting function.
- Try pressing the input button on the remote control or INPUT SELECTOR on the receiver to select the equipment of your choice.
- Check that headphones are not connected.
- When you want to listen to the sound from the TV speaker, set “Audio Out” to “TV+AMP” in the HDMI Settings menu. If set to “AMP,” the sound is not output through the TV speaker. If you output the multi-channel sound from the receiver, set to “AMP.”
- Sound may be interrupted when the sampling frequency, the number of channels or audio format of audio output signals from the playback equipment is switched.
- Set the “EQ” setting of the iPhone/iPod to “Off” or “Flat.”

There is severe hum or noise.

- Check that the speakers and equipment are connected correctly.
- Check that the connecting cords are away from a transformer or motor, and at least 3 meters away from a TV set or fluorescent light.
- Move your TV away from the audio equipment.

- Make sure you have grounded the \hbar SIGNAL GND terminal (only when a turntable is connected).
- The plugs and jacks are dirty. Wipe them with a cloth slightly moistened with alcohol.

There is no sound from specific speaker(s).

Front

- Connect headphones to the PHONES jack to verify that sound is output to the headphones.
If only one channel is output to the headphones, check that all the cords are fully inserted into the jacks on both the receiver and the equipment.
If both channels are output to the headphones, check the connection of the front speaker which is not outputting any sound.
- Make sure you have connected both the L and R jacks to an monaural equipment, analog equipment requires both L and R jack connections. Use a monaural-stereo cable (not supplied). However, there will be no sound from the center speaker when a sound field (Pro Logic, etc.) is selected.

Center/surround/surround back

- Check that the speaker settings are appropriate for the setup using “Auto Calibration” or “Speaker Connection” in the Speaker Settings menu. And then check that sound is output from each speaker correctly, using “Test Tone” in the Speaker Settings menu.
- Select the “HD-D.C.S.” sound field (page 72).
- Adjust the speaker level (page 104).
- Make sure the center/surround speaker(s) is (are) set to either “Small” or “Large.”

Surround back

- Some discs have no Dolby Digital Surround EX information.
- If the speaker pattern is set so that there are no surround back speakers, the input signals to the SUR BACK jacks is invalid, because the receiver cannot down-mix the surround back channels.

Subwoofer

- Check that the subwoofer is connected correctly and securely.
- Make sure you have turned on your subwoofer.

There is no sound from a specific equipment.

- Check that the equipment is connected correctly to the audio input jacks for that equipment.
- Check that the cord(s) used for the connection is (are) fully inserted into the jacks on both the receiver and the equipment.
- Set the INPUT MODE to “AUTO” (page 88).

HDMI input

- When “2ch Analog Direct” is being used, the sound is not output. Use other sound field (page 71).
- Check the HDMI connection (page 30, 32, 34, 37).
- Check that you use an HDMI cable that have an HDMI logo authorized by HDMI Licensing LLC.
- Depending on the playback equipment, equipment may need to be set up. Refer to the operating instructions supplied with the each equipment.
- Be sure to use a connecting cable for the HDMI jack corresponding to High Speed HDMI cable when you view images or listen to sound during a 1080p, Deep Color, or 3D transmission.
- Sound may not be output from the receiver while the GUI appears on the TV screen. Press HOME to turn the GUI off.

- Audio signals (format, sampling frequency, bit length, etc.) transmitted from an HDMI jack may be suppressed by the connected equipment. Check the setup of the connected equipment if an image is poor or the sound does not come out of an equipment connected via the HDMI cable.
- When the connected equipment is not compatible with copyright protection technology (HDCP), the image and/or the sound from the HDMI OUT jack may be distorted or may not be output. In this case, check the specification of the connected equipment.
- Set the image resolution of the player to more than 720p/1080i to enjoy High Bitrate Audio (DTS-HD Master Audio, Dolby TrueHD).
- The image resolution of player may need certain settings be made before you can enjoy DSD and multi-channel Linear PCM. Refer to the operating instructions of the player.
- Make sure the TV is compatible with the System Audio Control function.
- If the TV does not have System Audio Control function, set the “Audio Out” settings in the HDMI Settings menu to
 - “TV+AMP” if you want to listen to the sound from the TV speaker and receiver.
 - “AMP” if you want to listen to the sound from the receiver. When you connect the receiver to a video equipment (projector, etc.), sound may not be output from the receiver. In this case, select “AMP.”
- You cannot listen to the sound of an equipment connected to the receiver while a TV is selected as the input on the receiver.
 - Be sure to change the input of the receiver to HDMI when you want to watch a program on an equipment connected to the receiver.
 - Change the TV channel when you want to watch a TV broadcast.

- Be sure to select the correct equipment or input you want when you watch a program from the equipment connected to the TV.
- When using the Control for HDMI function, you cannot control the connected equipment using TV's remote control.
 - Depending on the connected equipment and TV, you may need to set up the HDMI setting of the equipment and TV. Refer to the operation instructions supplied with each equipment and TV.
 - Change the input of the receiver to the HDMI input connected to the equipment.

Coaxial/optical input

- When “2ch Analog Direct” is being used, the sound is not output. Use other sound field (page 71).
- Check the INPUT MODE (page 88).
- Check to make sure the selected audio (digital) input jack is not assigned to other inputs in “Audio Input Assign” in the Input Settings menu (page 88).

Analog 2 channel input

- Check to make sure the selected audio (analog) input jack is not assigned to other inputs in “Audio Input Assign” in the Input Settings menu (page 88).

The left and right sounds are unbalanced or reversed.

- Check that the speakers and equipment are connected correctly.
- Adjust the balance parameters using the “Speaker Setup” in the Speaker Settings menu.
- Adjust the level of the speakers.

Dolby Digital or DTS multi-channel sound is not reproduced.

- Check that the DVD, etc., you are playing is recorded in Dolby Digital or DTS format.
- When connecting the DVD player, etc., to the digital input jacks of this receiver, make sure the digital audio output setting on the connected equipment.

- You can enjoy High Bitrate Audio (DTS-HD Master Audio, Dolby TrueHD), DSD, and multi-channel Linear PCM with an HDMI connection only.

Multi-channel sound cannot be output.

- When “Control for HDMI” is set to “On,” “Audio Out” may be automatically set to “AMP.” In this case, set “Audio Out” to “AMP.”

The surround effect cannot be obtained.

- Make sure the sound field function is on (press MOVIE/HD-D.C.S. or MUSIC).
- “PLII (Movie/Music),” “PLIIX (Movie/Music),” “PLIIZ Height,” and “Neo:X (Cinema/Music/Game)” do not work when the speaker pattern is set to 2/0 or 2/0.1.

The MULTI CHANNEL DECODING lamp does not light up in blue.

- Check that the playback equipment is connected on a digital jack and the input is selected properly on this receiver.
- Check whether the input source of the software being played back corresponds to the multi-channel format.
- Check whether the setup on the playback equipment is set to multi-channel sound.
- Check to make sure the selected audio (digital) input jack is not assigned to other inputs in “Audio Input Assign” in the Input Settings menu (page 88).

Recording cannot be carried out.

- Check that the equipment are connected correctly (page 39).
- Select the source equipment (page 54).
- Audio input signals via the HDMI IN and MULTI CHANNEL INPUT jacks cannot be recorded.
- Check the connection of the recording deck according to the audio signals you want to record. Analog input signals can be output only from the analog output jacks. Digital audio input signals can be output only from the OPTICAL OUT jack.

- You may not make recordings using an SCMS-compliant recording deck.
- Copyright protection to prevent recording is contained in the sources. In this case, you may not be able to record from the sources.

A test tone is not output from the speakers.

- The speaker cords may not be connected securely. Check to see if they are connected securely and cannot be disconnected by pulling on them slightly.
- The speaker cords may have the short-circuit problem.

A test tone is output from a different speaker than the speaker displayed on the screen.

- The speaker configuration set up is incorrect. Make sure that the speaker connections and the configuration match correctly.

The H.A.T.S. function does not work.

- “Audio Out” is set to “TV+AMP.” Select “AMP” for “Audio Out.”
- The “H.A.T.S.” function may not work, depending on the speaker pattern or settings.

Tuner

The FM reception is poor.

- Use a 75-ohm coaxial cable (not supplied) to connect the receiver to an outdoor FM antenna (aerial) as shown on page 143. If you connect the receiver to an outdoor antenna (aerial), ground it against lightning. To prevent a gas explosion, do not connect the ground (earth) wire to a gas pipe.

Outdoor FM antenna (aerial)

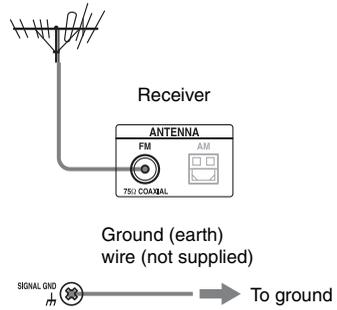

Radio stations cannot be tuned in.

- Check that the antennas (aerials) are connected securely. Adjust the antennas (aerials) and connect an external antenna (aerial), if necessary.
- Keep the satellite radio antenna, away from the speaker cords and the power cord to avoid picking up noise.
- The signal strength of the stations is too weak with automatic tuning. Use direct tuning.
- No stations have been preset or the preset stations have been cleared (when tuning by scanning preset stations is used). Preset the stations (page 63).
- Press DISPLAY MODE on the receiver so that the frequency appears on the display window.

The system cannot receive satellite channels at all.

- The receiving condition is not good. Move the antenna to the place where the condition is good.
- Check that you subscribed to the desired satellite radio service (page 64).

USB device

The USB device is not recognized.

- Turn off the receiver, then disconnect the USB device. Turn on the receiver again and reconnect the USB device.

continued

- Connect the supported USB device (page 55).
- The USB device does not work properly. Refer to the USB device operating instruction on how to deal with this problem.

Content on the USB device is not displayed.

- The hierarchy of folders has exceeded 4 levels. The receiver can display content in only up to 4 levels (including the “ROOT” folder). However, folders in a 4th level folder are not displayed.

No sound is output.

- Turn off the receiver, then disconnect the USB device. Turn on the receiver again and reconnect the USB device.
- Connect the supported USB device (page 55).
- Press ► to start playback.
- When “2ch Analog Direct” is being used, the sound is not output. Use other sound field (page 71).
- The music data itself contains noise, or the sound is distorted.
- Depending on the file format, there may be files that sometimes cannot be played back. For details, see “Playable types of files” (page 151).
- USB device formatted with file systems other than FAT12/16/32, VFAT, or NTFS are unsupported.*
- If you use partitioned USB device, only audio files on the first partition can be played back.
- Playback is possible up to 4 levels (including the “ROOT” folder).
- The number of files in a folder has exceeded 500 (including folders).
- Files that are encrypted or protected by passwords, etc. cannot be played back.
- If you play back music files stored on a WALKMAN using the receiver, move the files to the WALKMAN from a computer by “Click & Drop,” then save them on the

WALKMAN in a format supported by the receiver (e.g., MP3).

* This receiver supports FAT12/16/32, VFAT, or NTFS, but some USB device may not support all of these file systems.

For details, refer to the operating instruction of each USB device or contact the manufacturer.

The USB device cannot be connected into the (USB) port.

- The USB device is being connected upside down. Connect the USB device in the correct orientation.

Erroneous display.

- The data stored in the USB device may have been corrupted.
- The character codes that can be displayed by this receiver are as follows:
 - Upper case (A to Z)
 - Lower case (a to z)
 - Numbers (0 to 9)
 - Symbols (' < > * + , - . / @ [\] _ ')Other characters may not be displayed correctly.

It takes a long time before playback starts.

- The reading process can take a long time in the following cases.
 - There are many folders or files on the USB device.
 - The file structure is extremely complex.
 - The memory capacity is excessive.
 - The internal memory is fragmented.Thus, we recommend following the guideline.
 - Total files per folder: 500 or less

iPhone/iPod

The iPhone/iPod cannot be charged.

- Check that the receiver is turned on.
- Make sure the iPhone/iPod is connected firmly.

The iPhone/iPod cannot be operated.

- Check that you have removed the protect case of the iPhone/iPod.
- Depending on the contents of the iPhone/iPod, it may take time to start playback.
- Turn off the receiver, then disconnect the iPhone/iPod. Turn on the receiver again and reconnect the iPhone/iPod.
- You are using an unsupported iPhone/iPod. See “Compatible iPhone/iPod models” (page 60) for the supported device types.

The ring volume of the iPhone does not change.

- Adjust the ring volume using the controls on the iPhone.

Network

Cannot connect to the network.

- Check the network connection (page 45) and the Network Settings menu (page 115).

Cannot find the server.

- Search the server using “Connection Server Settings” in the Network Settings menu (page 115).
- Check the following:
 - Is the router turned on?
 - If there is another device between the receiver and the router, check that device is turned on.
 - Are all of the cables connected correctly and securely?
 - Is the settings to make sure that they match the router’s settings (DHCP or fixed IP address)?
- When using a computer, check the following:
 - The built-in firewall settings for the computer’s operating system.
 - The firewall settings of your security software. To check the firewall settings of your security software, refer to your security software’s Help section.

- Register the receiver with the server. For details, refer to the instructions supplied with the server.
- Wait for a few moments, and then try connecting to the server again.

Cannot find or play back the content on the server.

- On the “My Music,” “My Photo,” and “My Video” screens, the receiver displays only the content that can be played back with the receiver from among the content offered by the server within the DLNA guidelines.
- There may be content that is not played back or displayed even if that content is defined in the DLNA guidelines.

Cannot access the receiver from “ES Remote” or the DLNA controller.

- Make sure the controller you want to use is set to “Allow” in “Renderer Access Control” (page 115).
- If you set “Auto Access Permission” to “On” in “Renderer Options” (page 115), any controller detected can be available automatically.
- Is the network controller listed on “Renderer Options,” and is it set to “Allow”?

If the box is not checked, check the box for “Auto Access Permission,” and return to the home menu. Then, operate the receiver using the network controller once, and then uncheck the box for “Auto Access Permission,” if necessary.
- If the network controller is a computer software controller, is the software filtered by antivirus software or firewall software? Permit UPnP communications between the software and the receiver. For details, refer to the operating instructions of the antivirus software, firewall software, or network controller software.

Internet video

The picture/sound is poor/certain programs display with a loss of detail, especially during fastmotion or dark scenes.

- Picture/sound quality may be poor, depending on Internet content providers.
- Picture/sound quality may be improved by changing the connection speed. Sony recommends a connection speed of at least 2.5 Mbps for standard definition video and 10 Mbps for high-definition video.
- Not all videos contain sound.

The picture is small.

- Press **▲** to zoom in.

Cannot play back content.

- Some Internet content requires registration via a computer before it can be played.

“BRAVIA” Sync (“Control for HDMI”)

The Control for HDMI function does not work.

- Check the HDMI connection (page 28, 30, 32, 34).
- Make sure “Control for HDMI” is set to “On” in the HDMI Settings menu.
- Make sure the connected equipment is compatible with the Control for HDMI function.
- Check the Control for HDMI settings on the connected equipment. Refer to the operating instructions of the connected equipment.
- If you change the HDMI connection, connect/disconnect the AC power cord (mains lead), or there is a power failure, repeat the procedures of “Preparing for the “BRAVIA” Sync” (page 84).
- When you select “HDMI B” or “OFF,” the Control for HDMI function does not work properly.

- If you select “HDMI A” or “HDMI A + B,” after you have selected “HDMI B” or “OFF,” the Control for HDMI function may not work properly for a while. This is because the equipment connected to the HDMI OUT A jack must re-recognize the receiver that is equipped with the Control for HDMI function. If the Control for HDMI function does not work properly for a long time, perform the steps given in “Preparing for the “BRAVIA” Sync” (page 84).
- The types and the number of equipment which can be controlled by the “BRAVIA” Sync are restricted in the HDMI CEC standard as follows.
 - Recording equipment (Blu-ray Disc recorder, DVD recorder, etc.): up to 3 equipment
 - Playback equipment (Blu-ray Disc Player, DVD player, etc.): up to 3 equipment
 - Tuner-related equipment: up to 4 equipment
 - AV receiver (audio system): up to 1 equipment

When you try to use the One-Touch Play function, input is not switched as intended.

- Check the assignment of the HDMI input (page 88). When you assign multiple inputs with the same HDMI input jack, if you use the One-Touch Play function on the equipment connected to the HDMI input, the previous input, in its original input sequence, is preferentially selected.

The Audio Return Channel (ARC) does not work.

- Make sure “Control for HDMI” is set to “On” in the HDMI Settings menu.
- Make sure that the INPUT MODE for “TV” is set to “AUTO” (page 88).

Remote control

The remote control does not function.

- Point the remote control at the remote sensor on the receiver (page 10).
- Remove any obstacles in the path between the remote control and the receiver.
- Replace all the batteries in the remote control with new ones, if they are weak.
- Make sure that the command modes of the receiver and the remote control are the same. If the command mode of the receiver and the remote control are different, you cannot operate the receiver with the remote control (page 95).
- Make sure you select the correct input on the remote control.
- When you operate a programmed non-Sony equipment, the remote control may not function properly, depending on the model and the maker of the equipment.

The RM SET UP button flashes and you cannot set up Macro Play (page 132) or the remote control cannot learn a remote control code (page 133).

- When the RM SET UP button flashes five times, replace the batteries with new ones.

If the trouble is other than one of the cases described above and the trouble is not solved even if you wait for a while, perform either of the operations below.

- Press **I/⏻** on the remote control to turn the receiver off and then on again.
- Hold down **I/⏻** on the receiver until the lamp above the button flashes in green to reboot the receiver.

Error messages

You can check the status of the receiver by the message. See the following table to solve the problem. If any problem persists, consult your nearest Sony dealer.

PROTECTOR

The receiver is covered and ventilation holes are blocked. The receiver will automatically turn off after a few seconds. Remove the object covering the upper panel of the receiver and turn on the power again.

SPEAKER SHORTED

Irregular current is output to the speakers due to a short circuit on the speaker terminals. The receiver will automatically turn off after a few seconds. If the protective device on the receiver is activated due to a short-circuit problem, turn off the receiver. Check the connection of the speakers and turn on the power again.

FAN STOPPED

Check that the ventilation hole on the top of the receiver are not blocked. Place the receiver in a location with adequate ventilation to prevent heat build-up in the receiver.

“A new software version is available. Please go to the “Setup” section of the menu and select “Network Update” to perform the update.” appears on the TV screen.

See “Network Update” (page 119) to update the receiver to a newer software version.

Video cannot be output from this jack.

- If you use the receiver in main zone, connect the receiver to a TV via an HDMI cable.
- If you connect the receiver to a TV via a video cord, set “Playback Resolution” to “480i/576i” (page 111).
- If you connect the receiver to a TV via a component video cord, set “Playback Resolution” to a parameter appropriate to your TV (page 111).

Message list after Auto Calibration measurement

Display	Explanation
Code 31	SPEAKERS (A/B/A+B/OFF) is set to OFF. Set to other speaker settings and reperform the measurement.
Code 32	None of the speakers were detected. Make sure that the plug of the optimizer microphone is inserted all the way inside the AUTO CAL MIC jack, then reperform the Auto Calibration function.
Code 33	<ul style="list-style-type: none"> • None of the front speakers are connected or only one front speaker is connected. • The optimizer microphone is not connected. Make sure that the plug of the optimizer microphone is inserted all the way inside the AUTO CAL MIC jack, then reperform the Auto Calibration function. • Either the left or right surround speaker is not connected. • Surround back speakers are connected even though surround speakers are not meant to be connected. Connect the surround speaker(s) to the SURROUND terminals. • The surround back speaker is connected only to the SURROUND BACK (ZONE 2) R terminals. When you connect only one surround back speaker, connect it to the SURROUND BACK (ZONE 2) L terminals. • Only one front high speaker is connected. Connect the front high speaker to each of the FRONT [B]/FRONT HIGH terminals. • Front high speakers are connected even though surround speakers are not connected. Connect the surround speaker(s) to the SURROUND terminals.
Code 34	Speakers are not placed in the proper position. Speakers or an optimizer microphone on the right or left may be placed wrongly. See “1: Installing speakers” (page 24) and check the speaker position.
Warning 40	The measurement process has completed with high noise level detection. You may be able to achieve better results if you try in a quiet environment again.
Warning 41	The input from the microphone is too big.
Warning 42	<ul style="list-style-type: none"> • It may be too close the distance between the speaker and the microphone. Retry the measurement after setting apart from each other. • When you use the receiver as a pre-amplifier, either messages may appear, depending on the power amplifier you connect. However, there will be no problems, even if you continue to use the receiver without changes.
Warning 43	The distance and position of a subwoofer cannot be detected. Or the angle of the speaker position cannot be detected. This may be caused by noise. Try to perform the measurement in a quiet environment.
Warning 44	Measurement has been completed. However the speakers are not placed in the proper position with respect to each other. See “1: Installing speakers” (page 24) and check the relative positions of the speakers.
NO WARNING	There is no warning information.
-----	No speakers are connected.

Clearing the memory

Reference sections

To clear	See
All memorized settings	page 48
Memory of the multifunction remote control	page 135

To clear the memory of the simple remote control

After removing the batteries, do not use the remote control for a few minutes.

Rebooting the receiver

If the buttons on the receiver or the remote control do not work due to a malfunction of the receiver, reboot the receiver.

Hold down **I/⏪** for 10 seconds.

When the lamp above **I/⏪** flashes in green, the reboot starts.

About support information

Refer to the following web site for details of the latest information on the receiver.

<http://www.sony.com/essupport>

Specifications

AUDIO POWER SPECIFICATIONS

POWER OUTPUT AND TOTAL HARMONIC DISTORTION:

With 8 ohm loads, both channels driven, from 20 – 20,000 Hz; rated 130 watts per channel minimum RMS power, with no more than 0.09% total harmonic distortion from 250 milliwatts to rated output.

Amplifier section

POWER OUTPUT^{1) 2)}

Rated Power Output at Stereo Mode

(8 ohms 20 Hz – 20 kHz,
THD 0.09%);
130 W + 130 W

Reference Power Output at Stereo Mode

(4 ohms 20 Hz – 20 kHz,
THD 0.15%);
130 W + 130 W

Reference Power Output

(8 ohms 1 kHz, THD 0.7%)
FRONT:
140 W + 140 W
CENTER: 140 W
SURROUND:
140 W + 140 W
SURROUND BACK:
140 W + 140 W

Reference Power Output

(4 ohms 1 kHz, THD 0.7%)
FRONT:
130 W + 130 W
CENTER: 130 W
SURROUND:
130 W + 130 W
SURROUND BACK:
130 W + 130 W

¹⁾ Measured under the following conditions:

Power requirements: 120 V AC, 60 Hz

²⁾ Depending on the sound field settings and the source, there may be no sound output.

Frequency response³⁾

PHONO	RIAA equalization curve ± 1.0 dB (20 Hz – 20 kHz)
MULTI CHANNEL INPUT, SA-CD/CD, TAPE, MD, TV, VIDEO 1/2, BD/DVD, SAT/CATV, GAME	10 Hz – 100 kHz ± 3 dB

³⁾ When “2ch Analog Direct” is being used.

Inputs (Analog)

PHONO	Sensitivity: 2.5 mV Impedance: 50 kohms S/N: 90 dB (A, 20 kHz LPF)
MULTI CHANNEL INPUT, SA-CD/CD, TAPE, MD, TV, VIDEO 1/2, BD/DVD, SAT/CATV, GAME	Sensitivity: 150 mV Impedance: 50 kohms S/N: 100 dB (A, 20 kHz LPF)

Inputs (Digital)

IN 1 (BD/DVD), IN 2 (VIDEO 1), IN 3 (SA-CD/CD) (Coaxial)	Impedance: 75 ohms S/N: 96 dB (A, 20 kHz LPF)
IN 1 (GAME), IN 2 (SAT/CATV), IN 3 (TV), IN 4 (MD) (Optical)	S/N: 96 dB (A, 20 kHz LPF)

Outputs

TAPE (REC OUT), VIDEO 1, ZONE 2, ZONE 3 (AUDIO OUT)	Voltage: 150 mV Impedance: 1 kohm
FRONT L/R, CENTER, SURROUND L/R, SURROUND BACK L/R, FRONT HIGH L/R, SUBWOOFER	Voltage: 2 V Impedance: 1 kohm

FM tuner section

Tuning range	87.5 – 108.0 MHz
Antenna (aerial)	FM wire antenna (aerial)
Antenna (aerial) terminals	75 ohms, unbalanced

AM tuner section

Tuning scale	Tuning range
10 kHz step	530 – 1,710 kHz
9 kHz step	531 – 1,710 kHz

Intermediate frequency

450 kHz

Antenna (aerial) Loop antenna (aerial)

Video section

Inputs/Outputs

Video: 1 V_{p-p}, 75 ohms

COMPONENT VIDEO:

Y: 1 V_{p-p}, 75 ohms

P_B: 0.7 V_{p-p}, 75 ohms

P_R: 0.7 V_{p-p}, 75 ohms

80 MHz HD Pass Through

HDMI Video

Input/Output (HDMI Repeater block)

640 × 480p @ 59.94/60 Hz

720 × 480p @ 59.94/60 Hz

1280 × 720p @ 59.94/60 Hz

1920 × 1080i @ 59.94/60 Hz

1920 × 1080p @ 59.94/60 Hz

720 × 576p @ 50 Hz

1280 × 720p @ 50 Hz

1920 × 1080i @ 50 Hz

1920 × 1080p @ 50 Hz

1280 × 720p @ 29.97/30 Hz

1920 × 1080p @ 29.97/30 Hz

1280 × 720p @ 23.98/24 Hz

1920 × 1080p @ 23.98/24 Hz

HDMI Video (3D)

Input/Output (HDMI Repeater block)

1280 × 720p @ 59.94/60 Hz

Frame Packing

Side-by-Side (Half)

Over-Under (Top-and-Bottom)

1920 × 1080i @ 59.94/60 Hz

Frame Packing

Side-by-Side (Half)

Over-Under (Top-and-Bottom)

1920 × 1080p @ 59.94/60 Hz

Side-by-Side (Half)

Over-Under (Top-and-Bottom)

- 1280 × 720p @ 50 Hz
 - Frame Packing
 - Side-by-Side (Half)
 - Over-Under (Top-and-Bottom)
- 1920 × 1080i @ 50 Hz
 - Frame Packing
 - Side-by-Side (Half)
 - Over-Under (Top-and-Bottom)
- 1920 × 1080p @ 50 Hz
 - Side-by-Side (Half)
 - Over-Under (Top-and-Bottom)
- 1920 × 1080p @ 23.98/24 Hz
 - Frame Packing
 - Side-by-Side (Half)
 - Over-Under (Top-and-Bottom)
- 1920 × 1080p @ 29.97/30 Hz
 - Frame Packing
 - Side-by-Side (Half)
 - Over-Under (Top-and-Bottom)
- 1280 × 720p @ 23.98/24 Hz
 - Frame Packing
 - Side-by-Side (Half)
 - Over-Under (Top-and-Bottom)
- 1280 × 720p @ 29.97/30 Hz
 - Frame Packing
 - Side-by-Side (Half)
 - Over-Under (Top-and-Bottom)

Playable types of files

Type of content	File format	Extensions
Video	MPEG-1 Video/PS ^{1) 2)}	“.mpg,” “.mpeg,”
	MPEG-2 Video/PS, TS ^{1) 3)}	“.m2ts,” “.mts”
	MPEG-4 AVC ^{1) 2)}	“.mkv,” “.mp4,” “.m4v,” “.m2ts,” “.mts”
	WMV9 ^{1) 2)}	“.wmv,” “.asf”
	AVCHD ²⁾	4)
	Xvid	“.avi”

Type of content	File format	Extensions
Music	MP3 (MPEG-1 Audio Layer III) ⁶⁾	“.mp3”
	AAC ^{1) 2) 5) 6)}	“.m4a”
	WMA9 Standard ^{1) 2) 5) 6)}	“.wma”
	LPCM ⁶⁾	“.wav”
Photo	FLAC ⁶⁾	“.flac”
	JPEG	“.jpg,” “.jpeg,” “.mpo”
	PNG	“.png”
	GIF	“.gif”

- 1) The receiver does not play coded files such as DRM.
- 2) The receiver does not play this file format on a DLNA server.
- 3) The receiver can only play standard definition video on a DLNA server.
- 4) The receiver plays AVCHD format files that are recorded on a digital video camera, etc. The AVCHD format disc will not play if it has not been correctly finalised.
- 5) The receiver does not play coded files such as Lossless.
- 6) Sampling frequency/bit depth supported: up to 192 kHz/24 bit

Notes

- Some files may not play depending on the file format, file encoding, recording condition, or DLNA server condition.
- Some files edited on a computer may not play.
- The receiver can recognise the following files or folders in USB devices:
 - up to folders in the 3rd tree
 - up to 500 files in a single tree
- The receiver can recognise the following files or folders stored in the DLNA server:
 - up to folders in the 18th tree
 - up to 999 files in a single tree
- Some USB devices may not work with this receiver.
- The receiver can recognise Mass Storage Class (MSC) devices (such as flash memory or an HDD), Still Image Capture Device (SICD) class devices and 101 keyboard (front USB jack only).

- To avoid data corruption or damage to the USB memory or devices, turn the receiver off when connecting or removing the USB memory or devices.
- Concerning the formats defined in the DLNA guidelines, the server is required to offer the content to which the format information defined in the DLNA guidelines has been added properly.

General

Power requirements 120 V AC, 60 Hz

Power consumption 480 W

Power consumption (during standby mode)
0.5 W (When “Control for HDMI” (page 113), “Pass Through” (page 113), “Network Standby” (page 115), and “RS232C Control” (page 118) are set to “OFF,” and the power for zone 2/zone 3 is turned off.)

Dimensions 430 mm × 187.5 mm × 420 mm
(17 in × 7 ³/₈ in × 16 ¹/₂ in)
(width/height/depth)
including projecting parts and controls

Mass (Approx.) 17.7 kg (39 lb 1 oz)

Supplied accessories

Operating Instructions (this manual)

Quick Setup Guide (1)

Software License Information (1)

Optimizer microphone ECM-AC1 (1)

FM wire antenna (aerial) (1)

AM loop antenna (aerial) (1)

AC power cord (mains lead) (1)

Multifunction remote control (1)

Simple remote control (1)

R6 (size-AA) batteries (4)

Speaker cord connection tool (1)

Design and specifications are subject to change without notice.

Standby power consumption 0.5 W.

Index

Symbols

⌚ SIGNAL GND terminal 44

Numerics

12V Trigger 117
 2 channel 71
 2ch Analog Direct 71
 2ch Stereo (mode) 71
 3D Output Settings 112
 5.1 channel 24
 7.1 channel 24
 9.1 channel 24

A

A.F.D. (mode) 72
 A/V Sync 108
 AC power cord (mains lead) 47
 Advanced Auto Volume 77, 107
 AM 62
 Antenna (aerial) 43
 Antenna Aiming 66
 Audio Input Assign 88, 114
 Audio Out 112
 Audio Return Channel (ARC) 86, 88
 Audio Settings 107
 Auto Calibration 101
 Auto Calibration Setup 101
 Auto Standby 118
 Auto Tuning 62
 Automatic Phase Matching 103

B

Bass 11, 77
 Berlin Philharmonic Hall 74
 Bi-amplifier connection 97
 Blu-ray Disc Player 30

C

Cable box 34
 Calibration Type 102
 Camcorder 37
 Category Mode 66
 CD player 39

Center Analog Down Mix 106
 Changing the display 126
 Clear
 receiver 48
 remote control 135
 Connection Server Settings 115
 Connections
 antenna (aerial) 43
 audio equipment 39
 monitor 28
 Network 45
 speakers 26
 video equipment 30
 Control for HDMI 113
 Crossover Frequency 105

D

D.C.A.C. (Digital Cinema Auto Calibration)
 101
 Decode Priority 108
 Digital Legato Linear (D.L.L.) 107
 Direct Tuning 62, 67
 Display 12, 121
 Distance Unit 106
 DLNA 57, 61
 Dual Mono 107
 DVD player 30
 Dynamic Range Compressor 108

E

Easy Automation 91
 Easy Setup 49, 101
 Effect type 73
 Equalizer 77, 107
 ES Remote 91
 External Control 115

F

Favorites 53
 FM 62
 Front Reference Type 102

G

GUI (Graphical User Interface) 28

H

H.A.T.S. 113
HD-D.C.S. 72
HD-D.C.S. (Effect type) 73
HDMI Settings 112
Home Theater Control 86

I

Initialize Personal Information 119
Input Edit 114
INPUT MODE 88
Input Settings 114
Internet content 57
Internet Services Settings 115
Internet Settings 115
Internet video 57
Internet Video Parental Control 116
Internet Video Unrated 116
IP Content Noise Reduction 58
iPhone/iPod 56, 60

J

Jazz Club 74

L

L.F.E. (Low Frequency Effect) 13
Language 118
Large 104
Line Out 81, 117
Listen 54
Live Concert 74
Lock Code 69

M

MASTER VOLUME 11
MD deck 42
Menu 52, 98
Messages
 Auto Calibration 148
 Error 147
 SIRIUS 70
Movie 72
Multi Zone 78

Music 74
Muting 54

N

Name In 102
Name Input 63
Neo:X (Cinema) 72
Neo:X (Game) 74
Neo:X (Music) 74
Network Settings 115
Network Standby 115
Network Update 119

O

One-Touch Play 85

P

Parental Control Area Code 115
Parental Control Password 115
Parental Lock 68
Pass Through 87, 113
Phase Audio 106
Phase Noise 105
PHONES 11
Playback Resolution 111
PlayStation 3 32
PLII (Movie) 72
PLII (Music) 74
PLIIX (Movie) 72
PLIIX (Music) 74
PLIIZ Height 72, 74, 75
Portable Audio 74
Position 101
PRE OUT 27
Preset channels 67
Preset stations 63
PROTECTOR 147

R

Radio ID 65
Recording 94, 95
Remote control 17–20, 48, 127–136
Renderer Access Control 115
Renderer Options 115
Resetting
 receiver 48
 remote control 135

Resolution 109
RS232C Control 118

S

Satellite radio 64
Satellite tuner 34
SB Assign 104
Scene Select 86
Screen Format 112
Server
 Preparing 51
Setting menu 98
Settings 98
Settings Lock 118
Sirius 64
Sirius satellite radio 64
Sleep timer 94
Small 105
Software Update Notification 118
Sound Effects 71
Sound Field 71, 108
Sound Field Mode 75, 108
Sound Optimizer 76, 107
Speaker Connection 104
Speaker impedance 49, 106
Speaker Pair Match 102
Speaker pattern 104
Speaker Relocation 103
Speaker Settings 101
Speaker Setup 104
SPEAKER SHORTED 147
SPEAKERS (A/B/A+B/OFF) 10, 50
Sports 74
Stadium 74
STEREO/MONO 62
Subwoofer Level 112
Subwoofer Low Pass Filter 112
Subwoofer Muting 107
Super Audio CD player 39
System Audio Control 85
System Information 119
System Power-Off 85
System Settings 118
SYSTEM STANDBY 128

T

Tape deck 44

Test Tone 105
TONE 11
TONE MODE 11, 48
Treble 11, 77
True Concert Mapping A/B 74, 75
Tuner 62
Tuning 62, 63
Turntable 44
TV Type 112

U

Up converting 22
USB 55
User Reference Edit 102

V

VCR 36
VIDEO 2 IN jacks 37
Video Direct 114
Video Input Assign 88, 114
Video Settings 109
Vocal Height 74

W

WALKMAN 55
Watch 54

Z

Zone Control 116
Zone Resolution 110
Zone Settings 116
Zone Setup 117